

CATÁLOGO DE
FERRAGENS E ACESSÓRIOS
PARA VIDROS TEMPERADOS



Glasspeças

20⁵ anos

EDIÇÃO 2017

Missão

Ser um parceiro confiável e com soluções adequadas para atender necessidades específicas de grandes, médios e pequenos pedidos nos diversos setores da construção, acabamento e engenharia, no atendimento à têmperas, vidraçarias e distribuidores.

Visão

Criar uma sinergia para que todos os departamentos da empresa, desde a seleção dos melhores fornecedores de insumos, até a entrega final do produto ao cliente, seja com o mais alto grau de qualidade, pontualidade e competitividade.

Valores

Qualificação da mão de obra, sucessivos investimentos em know-how e tecnologia e busca constante em soluções simples, econômicas e inovadoras são constantes em nossa longa atuação no mercado.



20 anos





Linha Santa Marina 03



Linha Mini 38



Linha 2000 44



Linha 3000 51



Linha Premium 64



Linha Ferragens Especiais 70



Linha Prolongador 76



Puxador Tubular 78



Acessórios 80

Ilustrações 1126 KDKE 82

Instruções de Montagem 84



Kit's 88



Aplicações 91

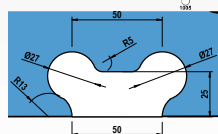

Recortes 95

Dicas úteis 116

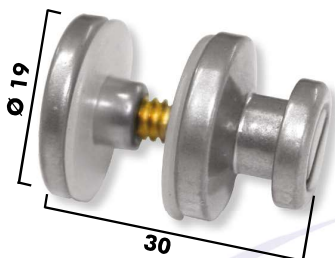

1001 G

Botão de Correção com Calota para Vidro

Disponível somente em Zamac

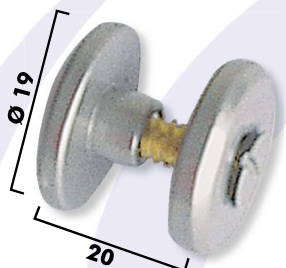
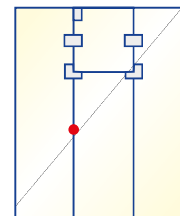

1002 G

Botão de Correção Simples (Parafuso)

Disponível somente em Zamac

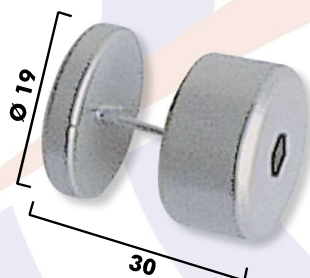
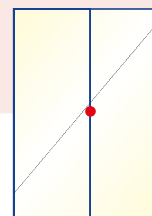

1002 A G

Botão de Correção (Lâmina)

Disponível somente em Zamac

Folga entre vidros 2mm

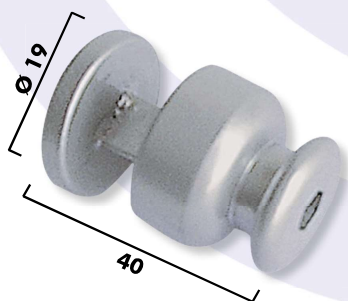
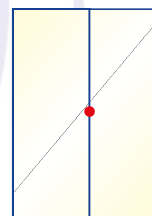

1002 B

Botão de Correção (Lâmina com Calota)

Folga entre vidros 2mm

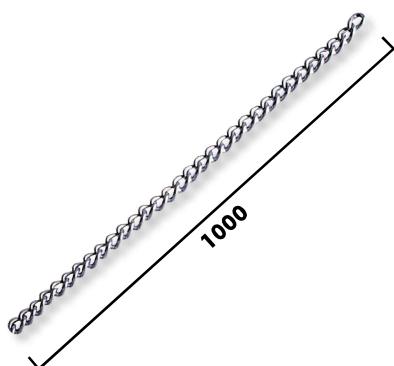
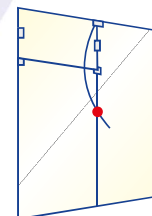

1003

Corrente para Trinco Basculante por Metro

Ferragem correspondente também ao código 3407 (Linha 3000)

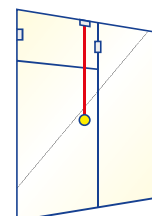



1003 A
Argola para Corrente
Ferragem correspondente também
ao código 3407A (Linha 3000)

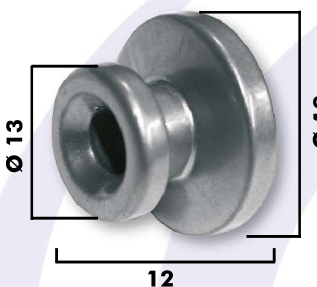
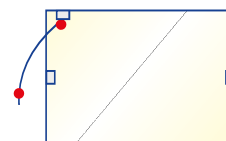

1005 G
Calota para Corrente
Ferragem correspondente também
ao código 3408 (Linha 3000)
Disponível somente em Zamac

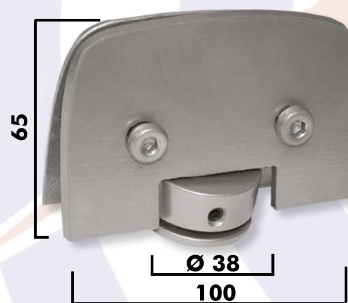
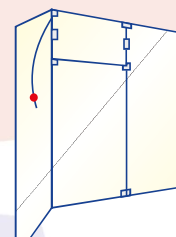

1007
Dobradiça com Freio para
Basculante e Pivotante
Vidro Alvenaria
Dimensões máximas recomendadas
1000x800mm
Quando utilizado em basculante
não deslocar o ponto de giro

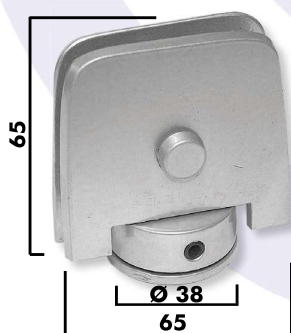
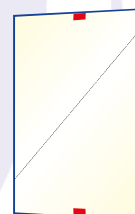

1007 A
Dobradiça com Freio para
Basculante e Pivotante
Vidro Alvenaria
Dimensões máximas recomendadas
800x700mm
Quando utilizado em basculante
não deslocar o ponto de giro

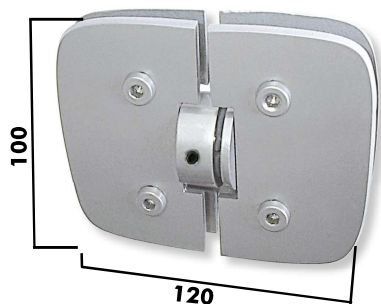
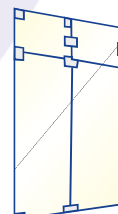

1008
Dobradiça com Freio para
Basculante e Pivotante
Vidro Vidro
Dimensões máximas recomendadas
1000x800mm
Quando utilizado em basculante
não deslocar o ponto de giro

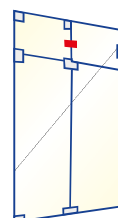

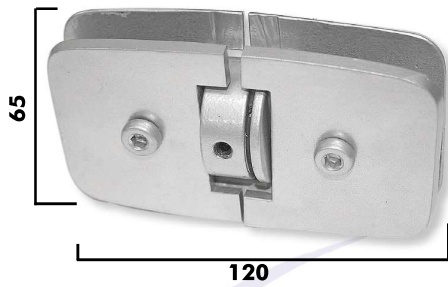

1008 A

Dobradiça com Freio para Basculante e Pivotante Vidro Vidro

Dimensões máximas recomendadas 800x700mm
Quando utilizado em basculante não deslocar o ponto de giro

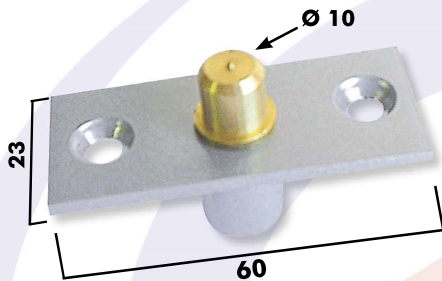
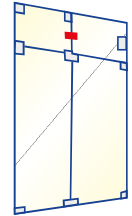

1009 G

Pivô Inferior para Dobradiças 1230, 1231

Disponível somente em Zamac

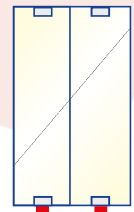

1013 G

Pivô Inferior para Dobradiças 1103, 1103 PGA, 1100I, 1103RM e 112F

Disponível somente em Zamac

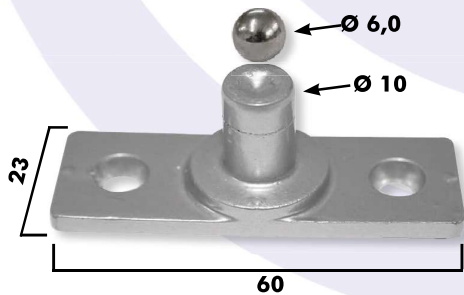
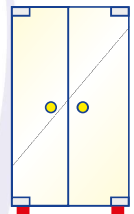

1013 SG

Pivô Inferior para Dobradiça 1103 Sul

Disponível somente em Zamac

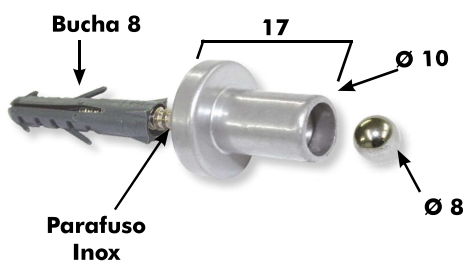
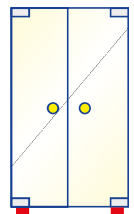

1013 PQ

Pivô Inferior em aço para Dobradiça 1103 Sul

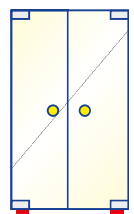

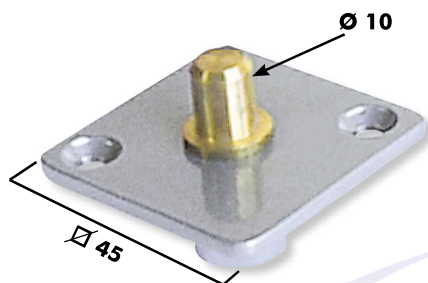

1014 G

Pivô para Dobradiças Inferiores
1103S, 1108, 1109, 1112, 1113

Disponível somente em Zamac

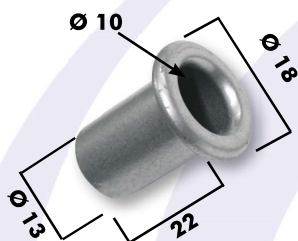
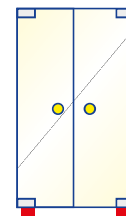

1038 G

Capuchinho para Trinco
com furo de 10mm

Disponível somente em Zamac

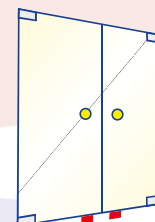

1038 AG

Capuchinho para Trinco
(Capelinha)

Disponível somente em Zamac

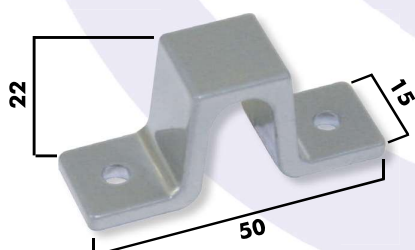
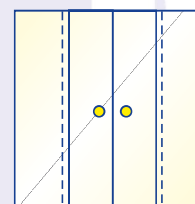

1038 BG

Capuchinho para Trinco 1335
Trilho Exposto

Disponível somente em Zamac

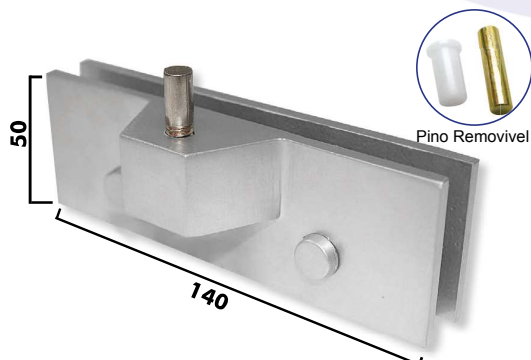
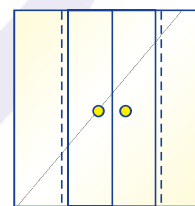

1100

Dobradiça Excêntrica Superior
Direita / Esquerda

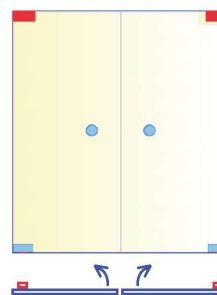

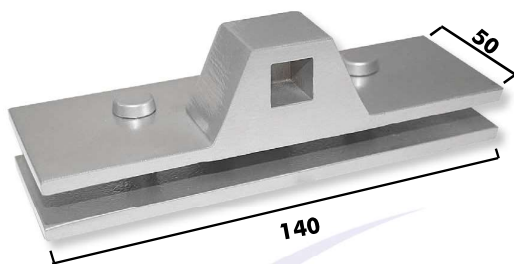

1100I
Dobradiça Excêntrica Inferior
Direita / Esquerda

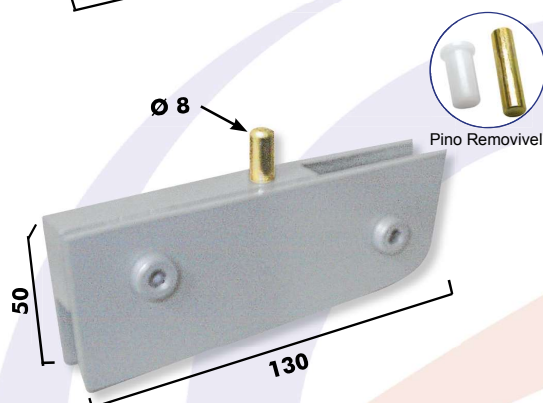
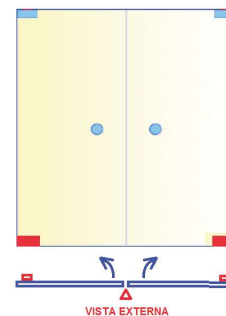

1101
Dobradiça Superior
Disponível em Latão e Zamac
Dimensões máximas recomendadas
1000x2200mm ou 900x2600mm

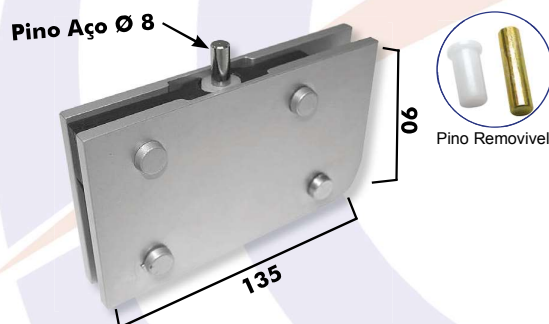
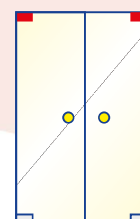

1101 PGA
Dobradiça Superior Reforçada
com 4 Furos (Alumínio)
Dimensões máximas recomendadas
1400x3000mm

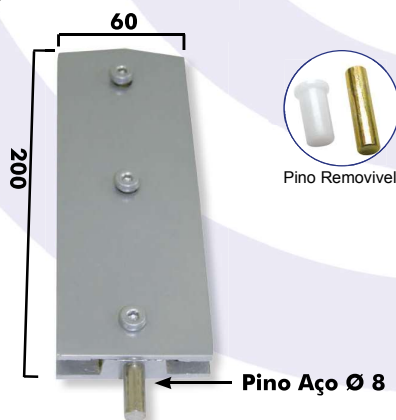
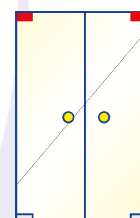

1101 R
Dobradiça Superior Reforçada
com 3 Furos
Dimensões máximas recomendadas
1200x2800mm
Portas com largura maior que 1200
deslocar a dobradiça

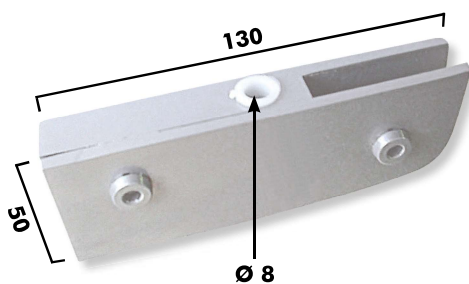
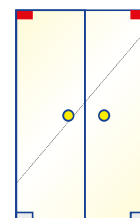

1101S
Dobradiça para Pivô Invertido
Sul
Disponível em Latão e Zamac
Dimensões máximas recomendadas
1000x2200mm ou 900x2600mm

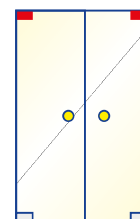

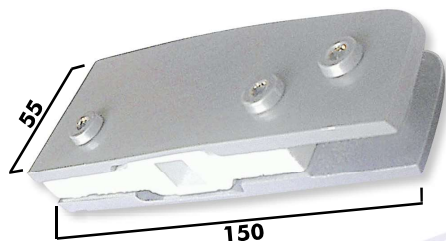

1103 Dobradiça Inferior

Disponível em Latão e Zamac
Dimensões máximas recomendadas
1000x2200mm ou 900x2600mm

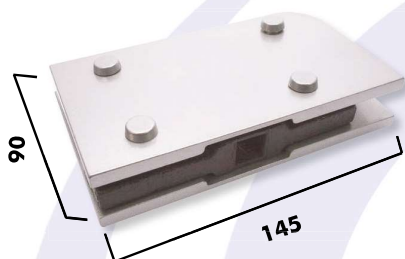
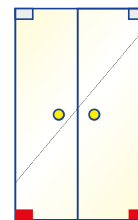

1103 PGA Dobradiça Inferior Reforçada com 4 Furos (Alumínio), Utilizadas em conjunto com pivô ou mola

Dimensões máximas recomendadas
1400x3000mm

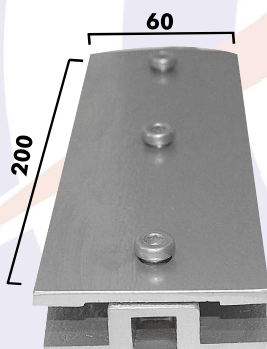
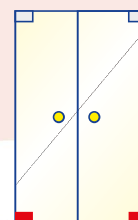

1103 RM Dobradiça Inferior Reforçada com 3 Furos; Utilizadas em conjunto com pivô ou mola

Dimensões máximas recomendadas
1200x2800mm
Portas maior que 1200mm de largura
deslocar a dobradiça

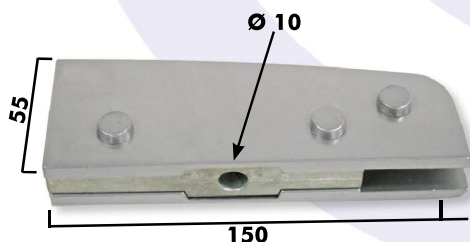

1103 S Dobradiça Inferior para Pivot Sul

Disponível em Latão e Zamac
Dimensões máximas recomendadas
1000x2200mm ou 900x2600mm

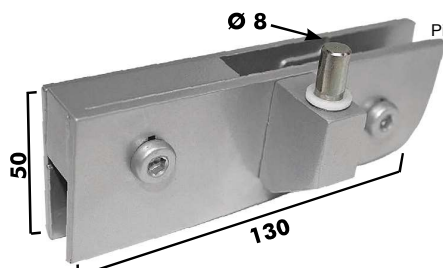
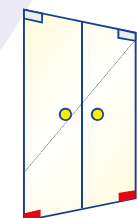

1104 G Dobradiça Superior Excêntrica Direita

Dimensões máximas recomendadas
1000x2100mm ou 900x2400mm
Disponível somente em Zamac

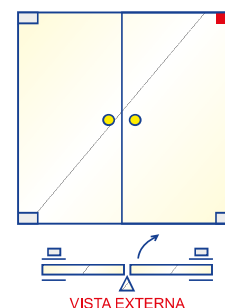

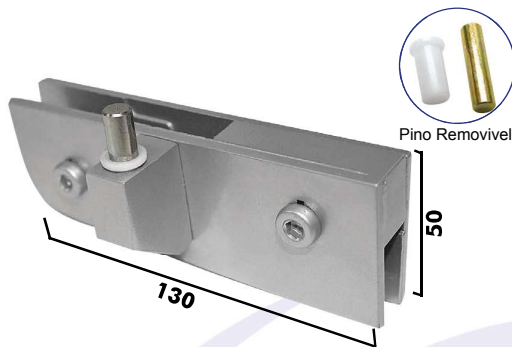

1105 G Dobradiça Superior Excêntrica Esquerda

Dimensões máximas recomendadas
1000x2100mm ou 900x2400mm
Disponível somente em Zamac

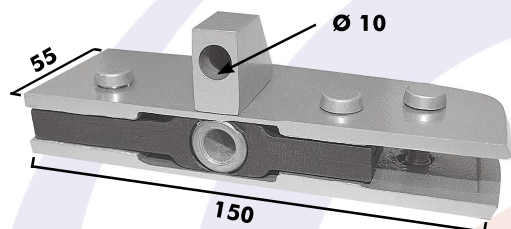
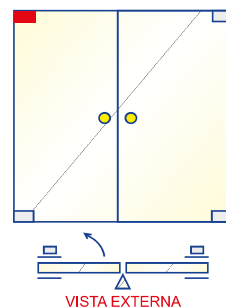

1108 Dobradiça Inferior Excêntrica Direita

Dimensões máximas recomendadas
1000x2100mm ou 900x2400mm

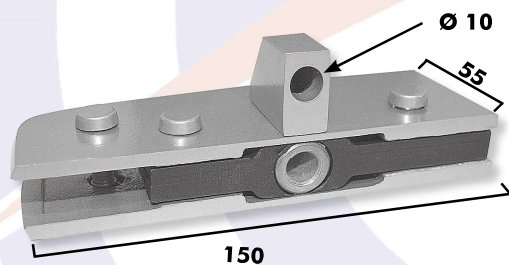
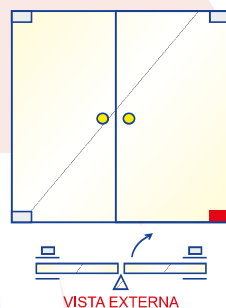

1109 Dobradiça Inferior Excêntrica Esquerda

Dimensões máximas recomendadas
1000x2100mm ou 900x2400mm

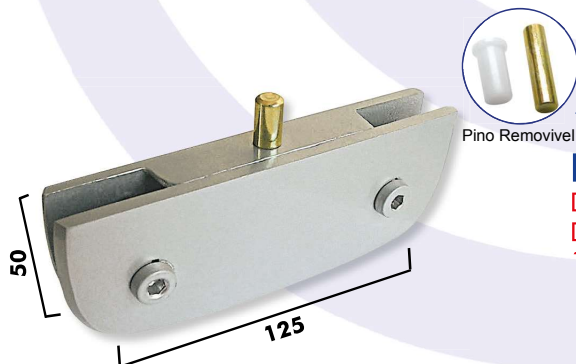
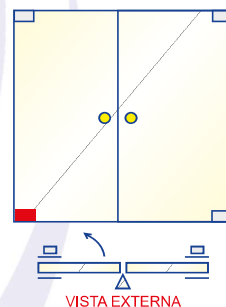

1110 Dobradiça Pivotante Superior

Disponível em Latão e Zamac
Dimensões máximas recomendadas
1000x2200mm

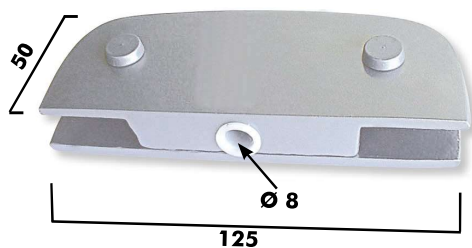
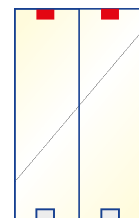

1112 Dobradiça Pivotante Inferior

Disponível em Latão e Zamac
Dimensões máximas recomendadas
900x2000mm

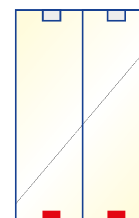

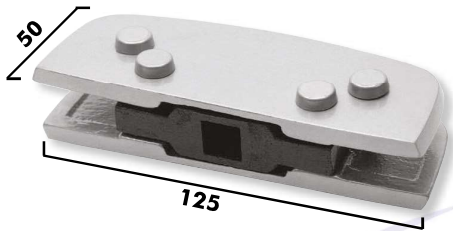

1112F
Dobradiça Pivotante Inferior
para Mola
Dimensões máximas recomendadas
1000x2200mm

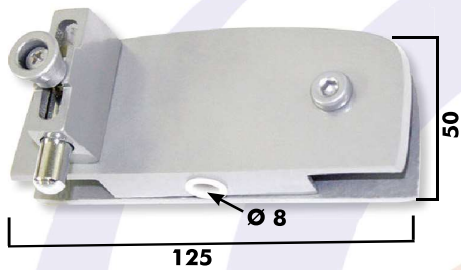
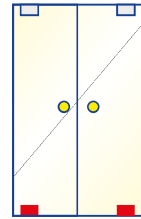

1113
Dobradiça Pivotante Inferior
com Trinco
Disponível em Latão e Zamac
Dimensões máximas recomendadas
900x2200mm

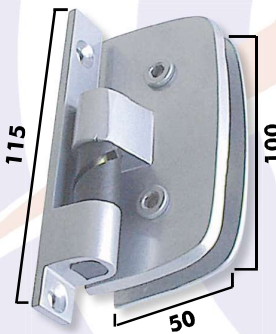
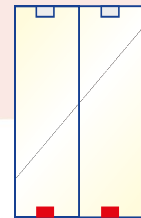

1114
Dobradiça Automática
para Box
Disponível em Latão e Zamac
Dimensões máximas recomendadas
600x1900mm - Vidro 8mm

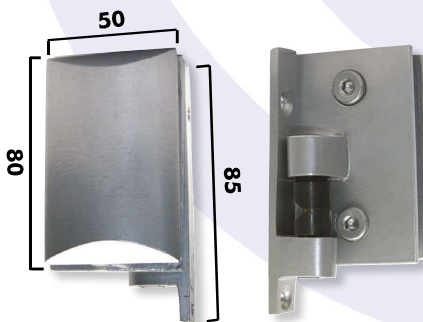
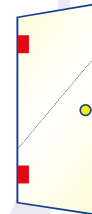

1114BG
Dobradiça Automática
para Box
Disponível somente em Zamac
Dimensões máximas recomendadas
600x1900mm - Vidro 8 mm

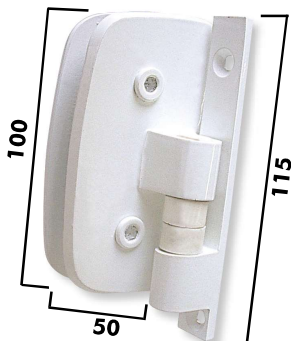
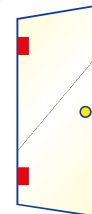

1115
Dobradiça sem Caimento
para Box
Disponível em Latão e Zamac
Dimensões máximas recomendadas
600x1900mm - Vidro 8mm

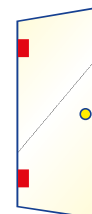

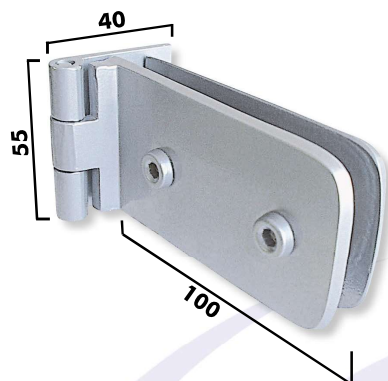

1116G

Dobradiça Lateral Horizontal Simples

Disponível somente em Zamac
Dimensões máximas recomendadas
700x2100mm
Indicado lubrificação periódica no pino

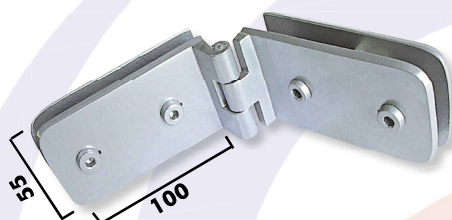

1117G

Dobradiça Horizontal Dupla

Disponível somente em Zamac
Dimensões máximas recomendadas
700x2100mm
Indicado lubrificação periódica no pino

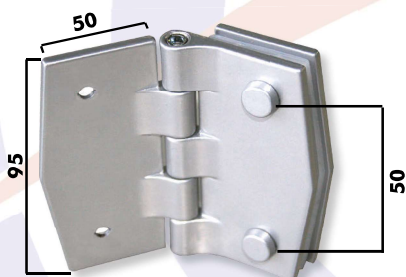
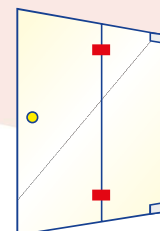

1118

Dobradiça de Batente V/A

Disponível em Latão e Zamac
Dimensões máximas recomendadas
800x2100mm
Indicado lubrificação periódica no pino

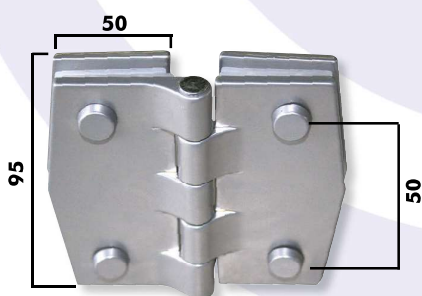
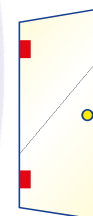

1118D

Dobradiça de Batente V/V

Disponível em Latão e Zamac
Dimensões máximas recomendadas
800x2100mm
Indicado lubrificação periódica no pino

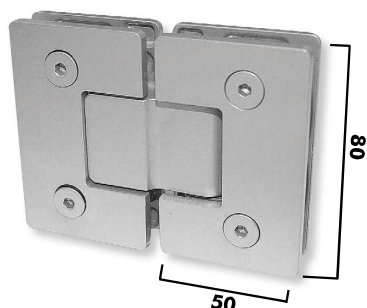
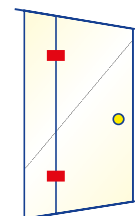

1119G

Dobradiça de Batente V/V com mola

Disponível somente em Zamac
Dimensões máximas recomendadas
650x1900mm

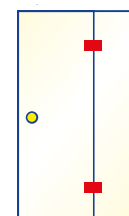

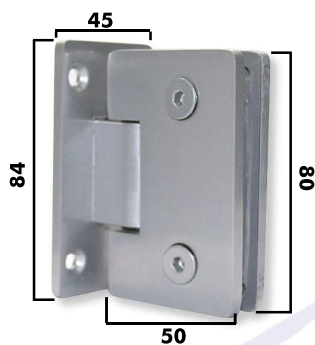

1120 G

Dobradiça de Batente V/A com mola e cavalete central

Disponível somente em Zamac
Dimensões máximas recomendadas
650x1900mm

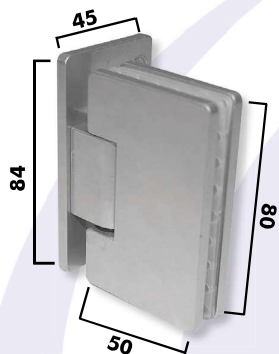

1121 G

Dobradiça de Batente V/A com mola e cavalete deslocado

Disponível somente em Zamac
Dimensões máximas recomendadas
650x1900mm

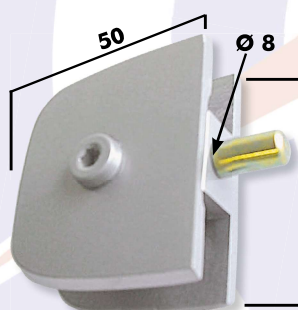

1123

Dobradiça para Vidro Basculante

Disponível em Latão e Zamac
Dimensões máximas recomendadas
800x700mm
Para altura do ponto de giro
 $X = \frac{(48.000 / A) + B}{2}$

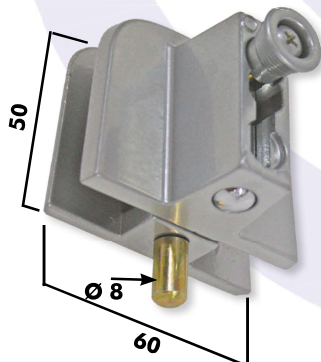
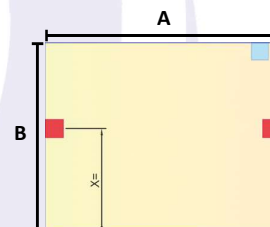

1123A

Dobradiça para Vidro Basculante com Trinco

Disponível em Latão e Zamac
Dimensões máximas recomendadas
800x700mm

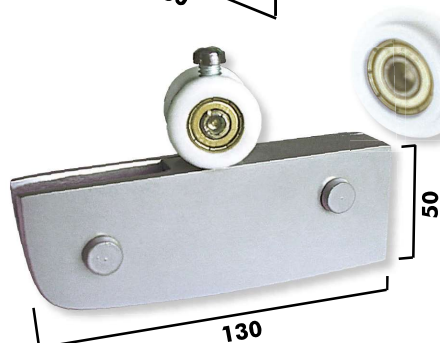

1124

Suporte Superior com Rodízio para Porta Sanfonada

Disponível com Roldana Côncava: Código 1124C
Disponível em Latão e Zamac
Dimensões máximas recomendadas
400x2100mm

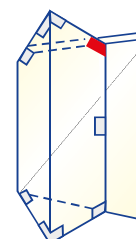



1125

Roldana Simples para Box e Janela de Correr

Dimensões máximas recomendadas
800x2100mm

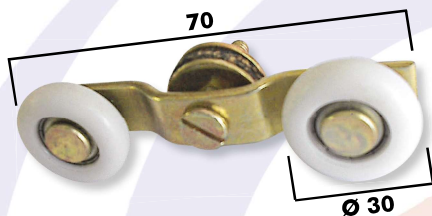
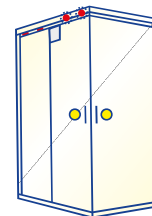

1125 D

Roldana Dupla para Janela de Correr

Dimensões máximas recomendadas
1300x2100mm

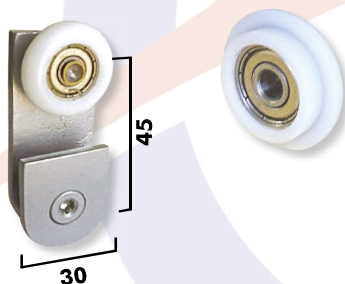
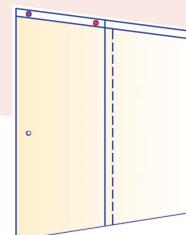

1126 B

Carrinho com Rolamento

Dimensões máximas recomendadas
500x1400mm - Vidro 8mm

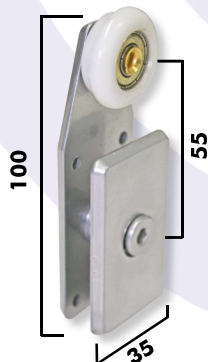
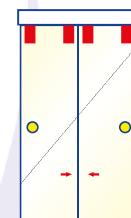

1126 M

Mini Carrinho para Porta de Correr com Rolamento

Disponível em Latão e Zamac
Dimensões máximas recomendadas
500x1500mm - Vidro 8mm

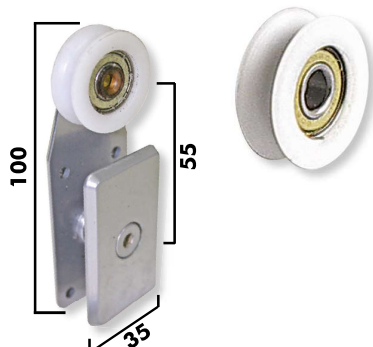
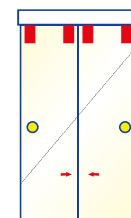

1126 MC

Mini Carrinho para Porta de Correr com Rolamento Côncavo

Disponível em Latão e Zamac
Dimensões máximas recomendadas
500x1500mm - Vidro 8mm

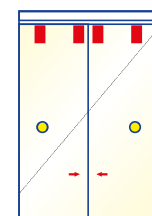

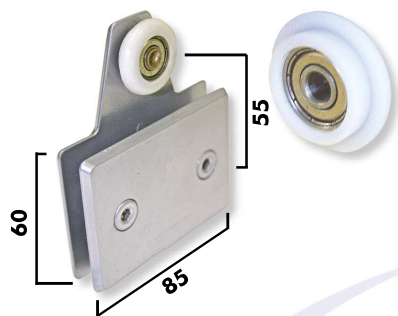

1126

Carrinho para Porta de Correr com Rolamento

Disponível em Latão e Zamac
Dimensões máximas recomendadas
600x1800mm - Vidro 8mm

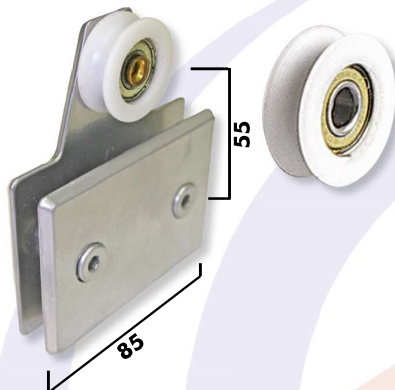
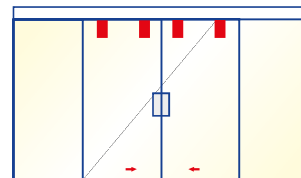

1126C

Carrinho para Porta de Correr com Rolamento Côncavo

Disponível em Latão e Zamac
Dimensões máximas recomendadas
600x1800mm

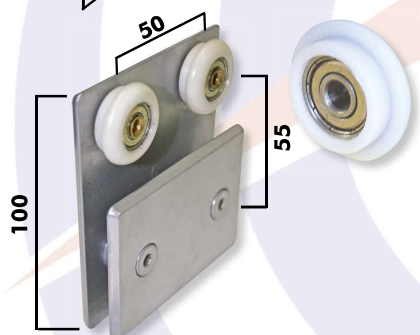
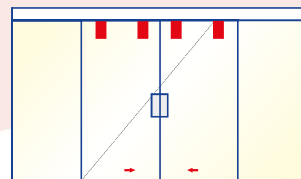

1126D

Carrinho Duplo para Porta de Correr com Rolamento

Disponível em Latão e Zamac
Dimensões máximas recomendadas
700x2100mm

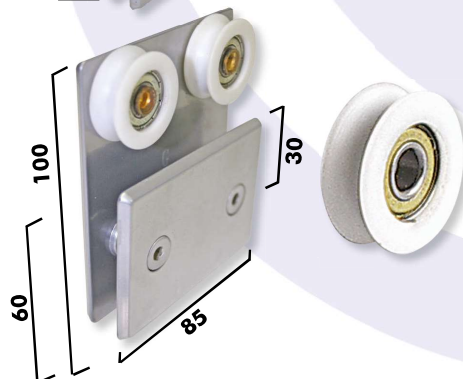
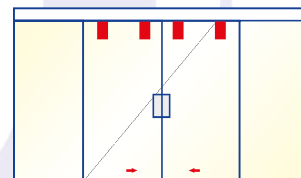

1126DC

Carrinho Duplo para Porta de Correr com Rolamento Côncavo

Disponível em Latão e Zamac
Dimensões máximas recomendadas
700x2100mm

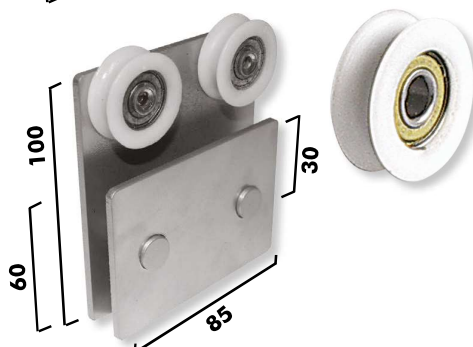
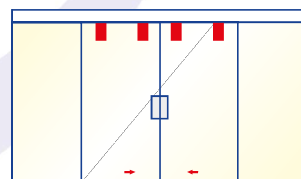

1126DCR

Carrinho Duplo para Porta de Correr com Rolamento Côncavo Reforçado

Disponível somente em Aço Carbono
Dimensões máximas recomendadas
900x2700mm

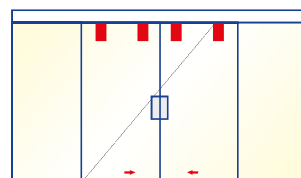

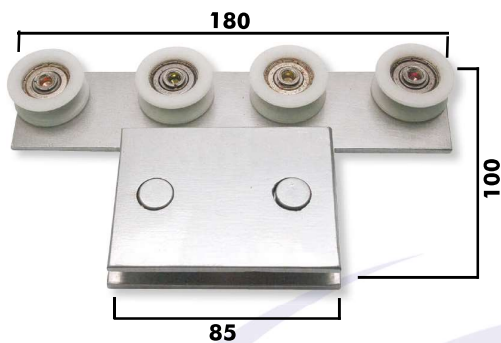

1126 QC

Carrinho Quádruplo
Côncavo

Dimensões máximas recomendadas
1200x3000mm

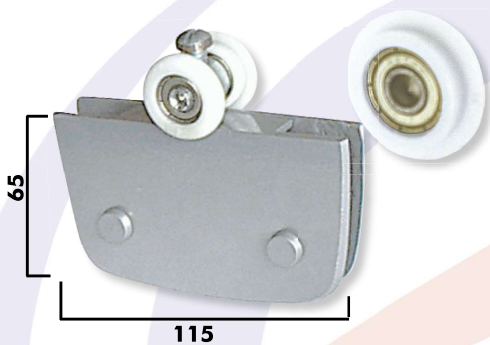
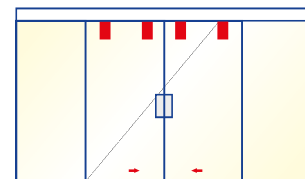

1127

Suporte Central para Porta
Sanfonada com Rodízio Duplo

Dimensões máximas recomendadas
700x2000mm

Disponível com Roldana Côncava
Código 1127 C -

Dimensões máximas recomendadas
800x2200mm

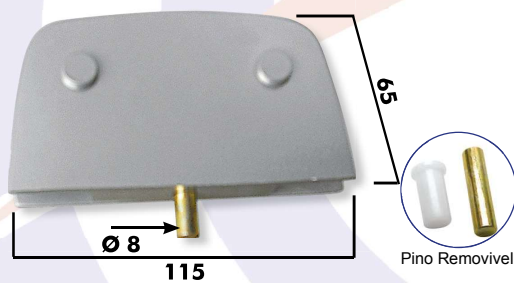
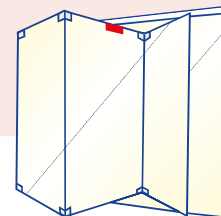

1127A

Suporte Central Inferior com
Pino para Porta Sanfonada

Pino Removível

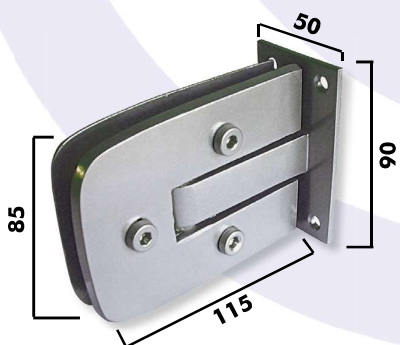
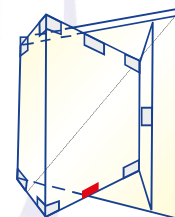

1128A

Dobradiça Lateral Horizontal
com Ponto de Giro a 65mm

Dimensões máximas recomendadas
1000x2100mm

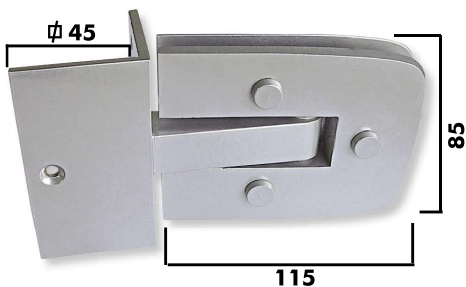
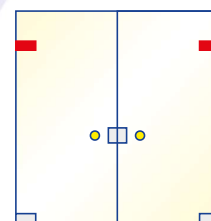

1128B

Dobradiça Horizontal de Canto
com Ponto de Giro a 65mm

Dimensões máximas recomendadas
1000x2100mm

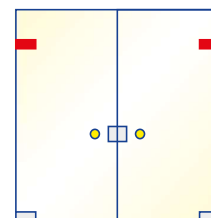

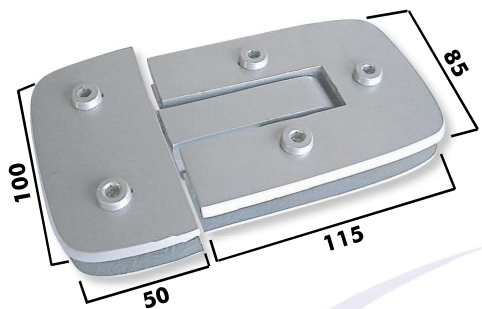

1128 C
Dobradiça Horizontal V/V
com Ponto de Giro a 65mm
Dimensões máximas recomendadas
1000x2100mm

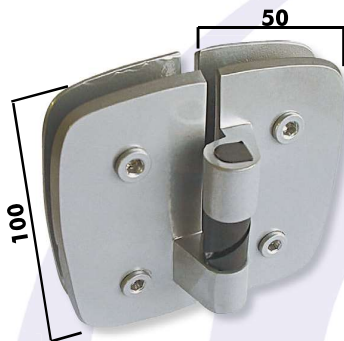
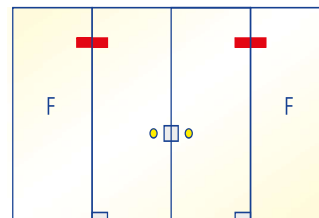

1129 D
Dobradiça Dupla Automática
V/V Direita
Disponível em Latão e Zamac
Dimensões máximas recomendadas
600x1900mm - Vidro 8mm

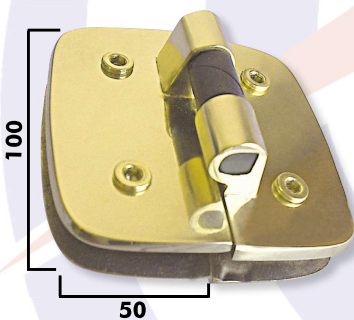
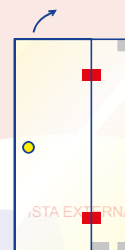

1129 E
Dobradiça Dupla Automática
V/V Esquerda
Disponível em Latão e Zamac
Dimensões máximas recomendadas
600x1900mm - Vidro 8mm

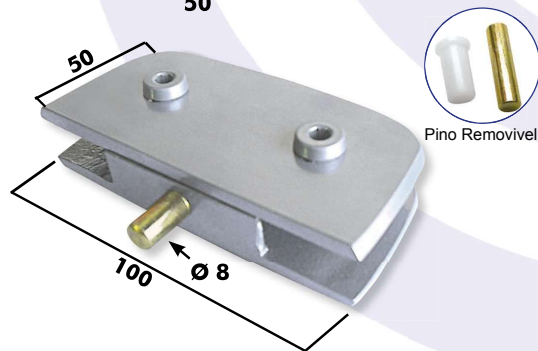
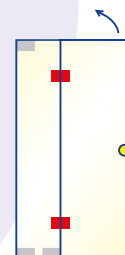

1130
Suporte para Basculante e
Pivotante com Pino
Disponível em Latão e Zamac
Dimensões máximas recomendadas
1000x800mm
 $X = \frac{(48.000 / A) + B}{2}$

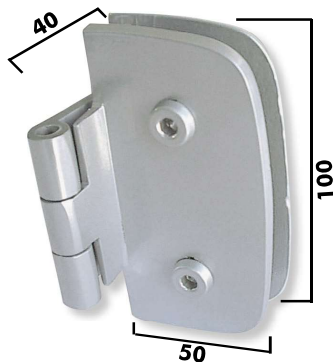
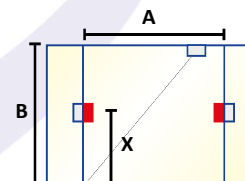

1131
Dobradiça para Porta em Arco
com Ponto de Giro Deslocado
a 25mm
Disponível em Latão e Zamac
Dimensões máximas recomendadas
700x2100mm
Indicado lubrificação periódica no pino

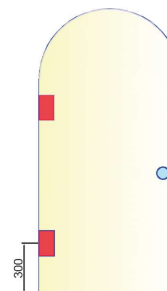

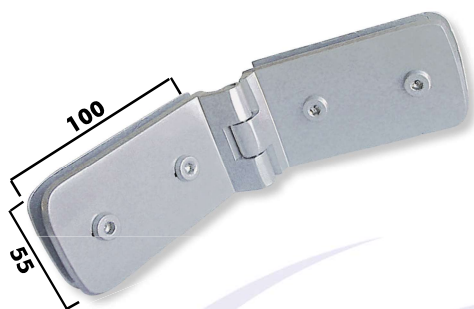

1132 G

Dobradiça Horizontal Dupla Superior e Inferior

Disponível somente em Zamac
(Apenas Equilíbrio)

Indicado lubrificação periódica no pino

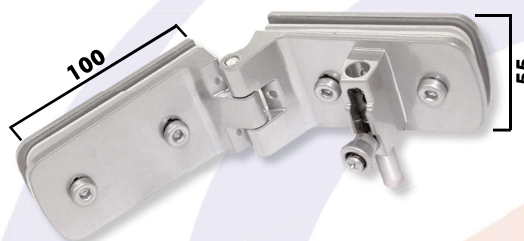
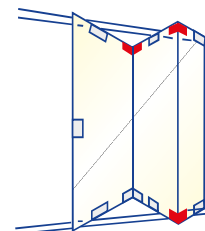

1132 A/B G (Universal)

Dobradiça Horizontal Dupla com Trinco

Disponível somente em Zamac
(Apenas Equilíbrio)

Indicado lubrificação periódica no pino

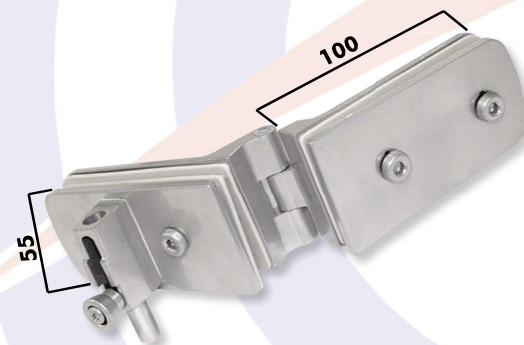
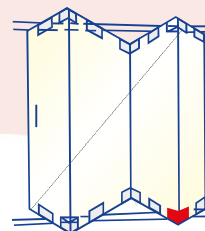

1132 C/D G (Universal)

Dobradiça Horizontal Dupla com Trinco

Disponível somente em Zamac
(Apenas Equilíbrio)

Indicado lubrificação periódica no pino

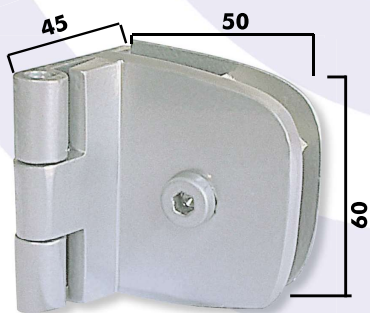
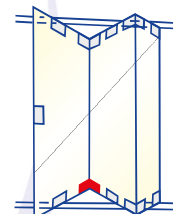

1136 G

Dobradiça Lateral Horizontal Giro Deslocado a 25mm

Disponível somente em Zamac
Dimensões máximas recomendadas
400x1600mm - Vidro 8mm

Indicado lubrificação periódica no pino

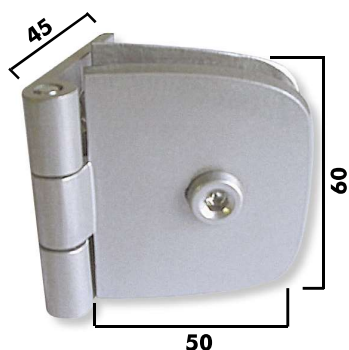
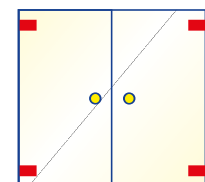

1136 B

Dobradiça Lateral de Batente sem Eixo de Giro

Dimensões máximas recomendadas
400x1600mm - Vidro 8mm

Indicado lubrificação periódica no pino

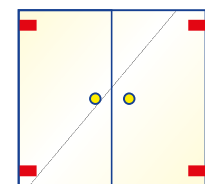

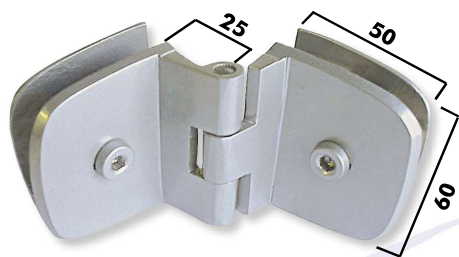

1137 G

Dobradiça Horizontal Dupla
Giro Deslocado a 25mm

Disponível somente em Zamac
Dimensões máximas recomendadas
400x1600mm - Vidro 8mm
Indicado lubrificação periódica no pino

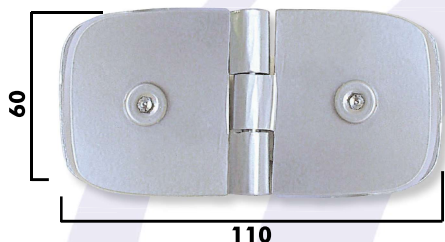
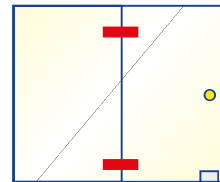

1137 B

Dobradiça Horizontal
Dupla V/V
sem Eixo de Giro

Dimensões máximas recomendadas
400x1600 - Vidro 8mm
Indicado lubrificação periódica no pino

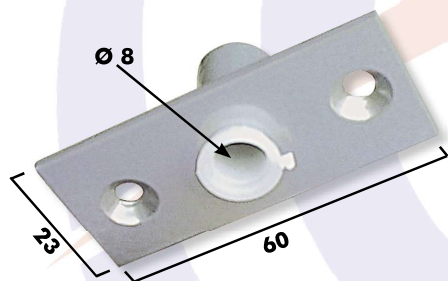
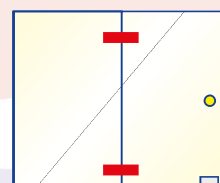

1201 G

Bucha para Pivot de Dobradiças
1101, 1123, 1110

Disponível somente em Zamac

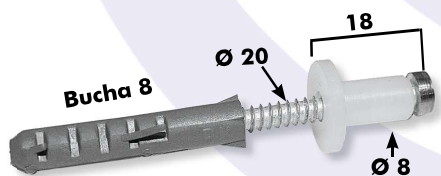
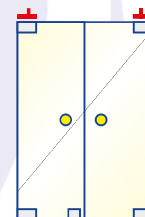

1201 PQ

Pivot superior em aço para
Dobradiças 1101S e 1230

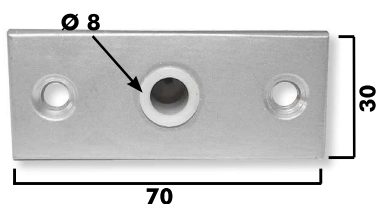
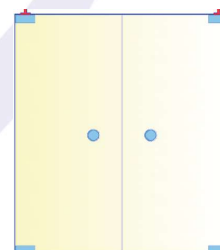

1201 R

Pivô Reforçado para Dobradiças
1101 R e 1101 PG

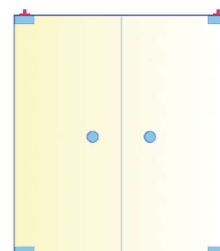

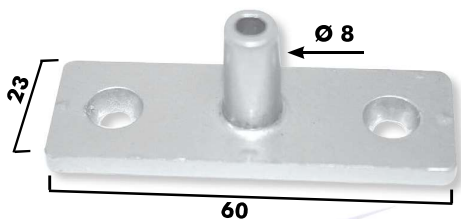

1201 SG

Pivot para Dobradiças
1101 S, 1230 e 1231

Disponível somente em Zamac

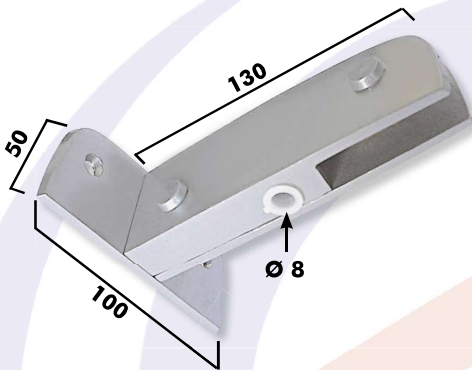
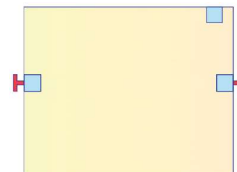

1203

Suporte para Bandeira com
Ponto de Giro para Dobradiça
Superior 1101

Disponível em Latão e Zamac

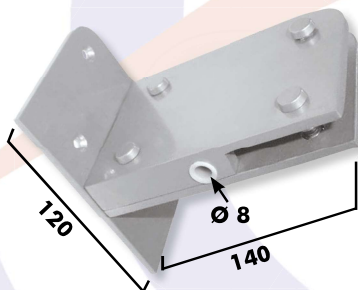
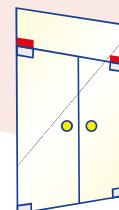

1203 PG

Suporte Reforçado para Bandeira
com Ponto de Giro para Dobradiça
1101PG (Somente Latão)

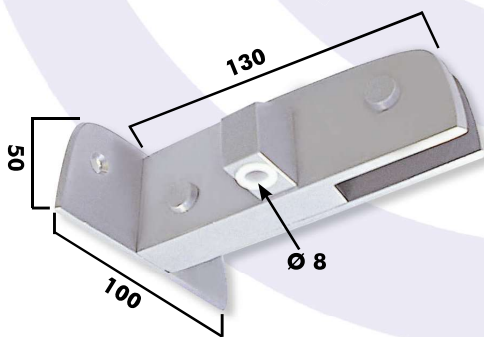
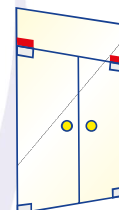

1206

Suporte para Bandeira com
Ponto de Giro Excêntrico
Direito

Disponível em Latão e Zamac

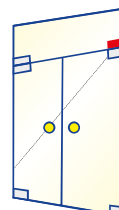

VISTA EXTERNA

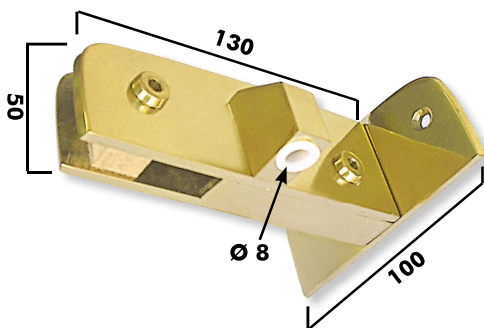

1207

Suporte para Bandeira com
Ponto de Giro Excêntrico
Esquerdo

Disponível em Latão e Zamac

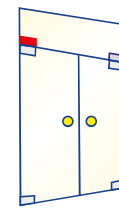

VISTA EXTERNA

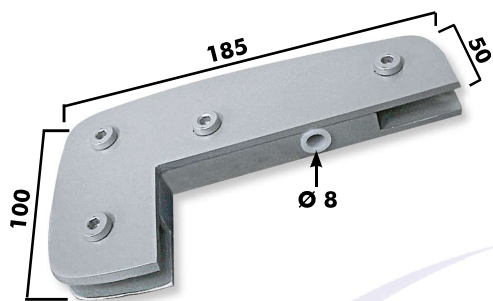

1209
Facão Simples para Lateral e Bandeira
Disponível em Latão e Zamac

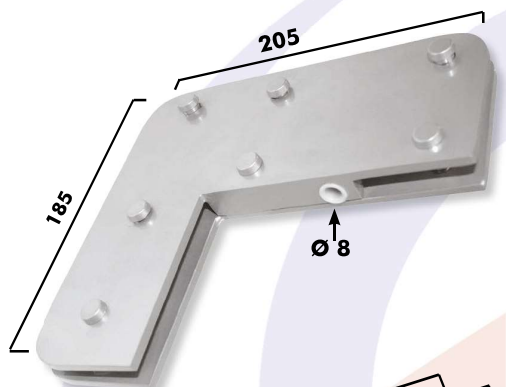
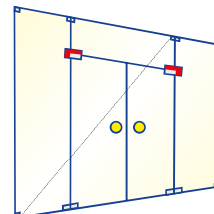

1209 PG
Facão VV para dobradiça 1101 PG (Somente Latão)

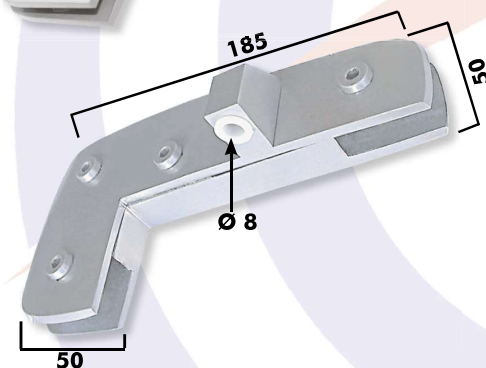
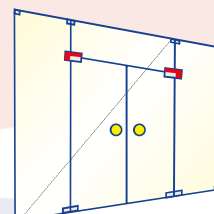

1214
Facão Direito para Lateral e Bandeira com Ponto de Giro Excêntrico
Disponível em Latão e Zamac

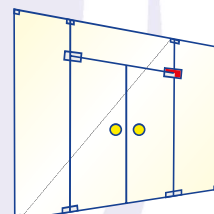

VISTA EXTERNA

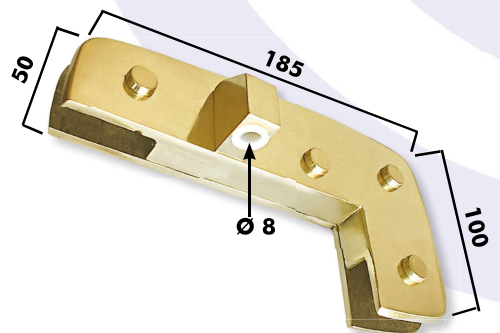

1215
Facão Esquerdo para Lateral e Bandeira com Ponto de Giro Excêntrico
Disponível em Latão e Zamac

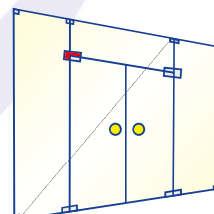

VISTA EXTERNA

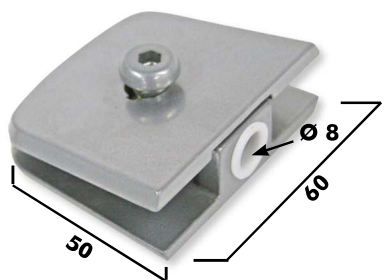

1230
Suporte para Basculante

Disponível em Latão e Zamac
Dimensões máximas recomendadas 800x700mm
 $x = \frac{(48.000 / A) + B}{2}$

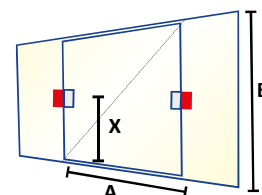

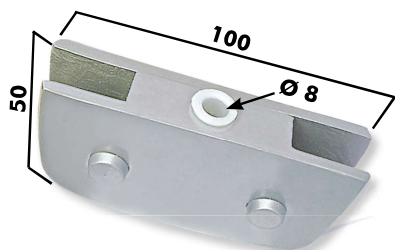

1231

Suporte com Ponto de Giro para Basculante e Pivotante

Disponível em Latão e Zamac
Dimensões máximas recomendadas
1000x800mm
 $X = \frac{(48.000 / A) + B}{2}$

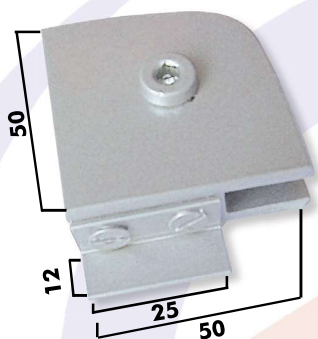
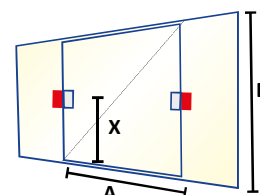

1301

Suporte de Canto para Bandeira com Batedeira Direita ou Esquerda

Disponível em Latão e Zamac

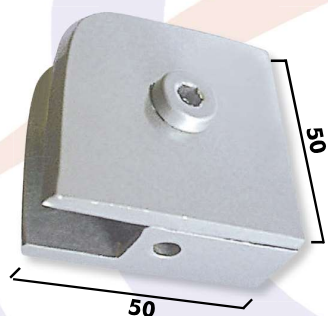
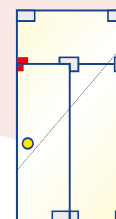

1302

Suporte de Canto

Disponível em Latão e Zamac

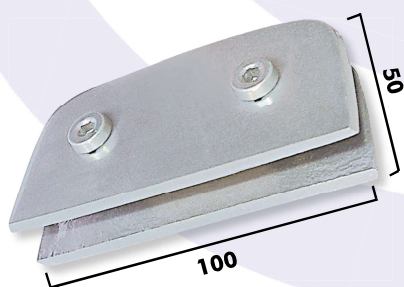
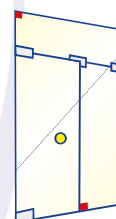

1304

Suporte sem Miolo para Dois Vidros

Disponível em Latão e Zamac

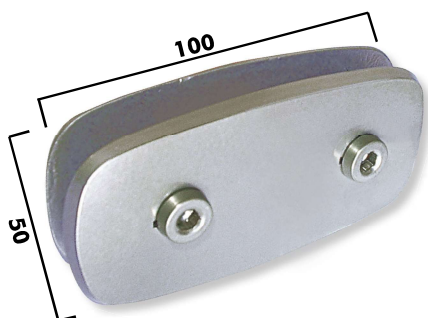
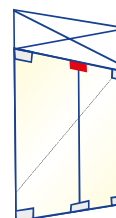

1305

Suporte para União de Dois Vidros sem Miolo

Disponível em Latão e Zamac

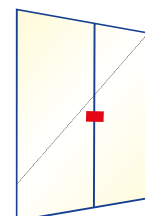

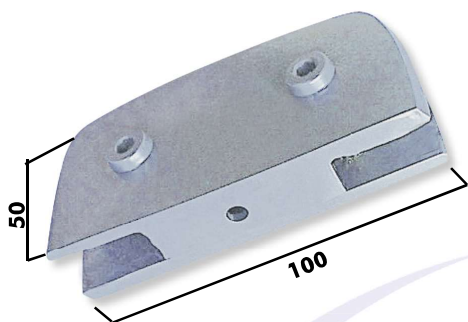

1306

Suporte com Miolo para União de Dois Vidros

Disponível em Latão e Zamac

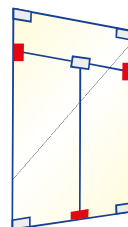

1307

Suporte sem Miolo para União de Três Vidros em "T"

Disponível em Latão e Zamac

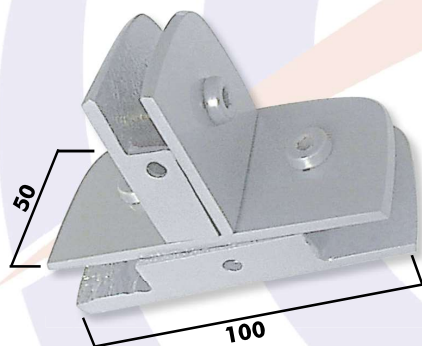
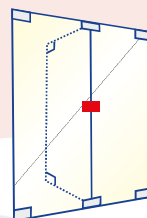

1308

Suporte com Miolo para União de Três Vidros em "T"

Disponível em Latão e Zamac

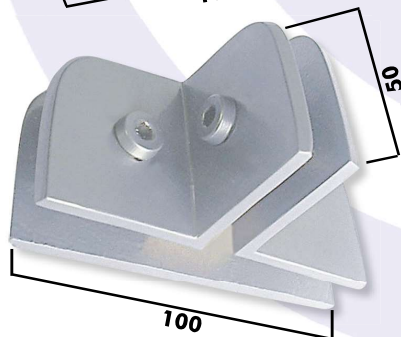
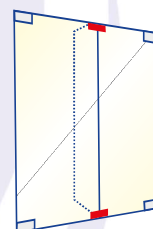

1309

Suporte sem Miolo para União de Três Vidros em "T"

Disponível em Latão e Zamac

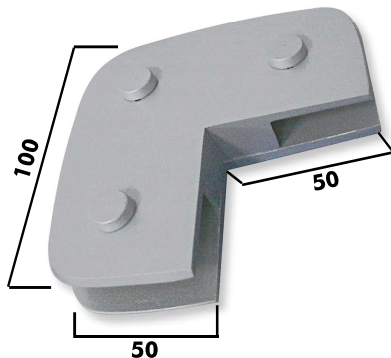

1310

Suporte para União de dois ou Três Vidros em "L"

Disponível em Latão e Zamac

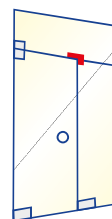

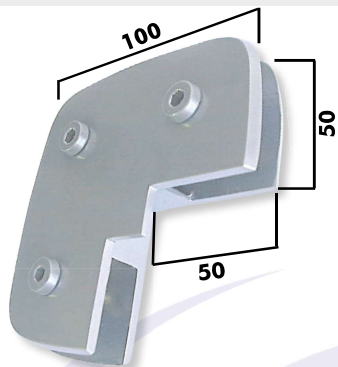

1315

Suporte para União de Dois ou Três Vidros em "L" com Batedeira

Disponível em Latão e Zamac

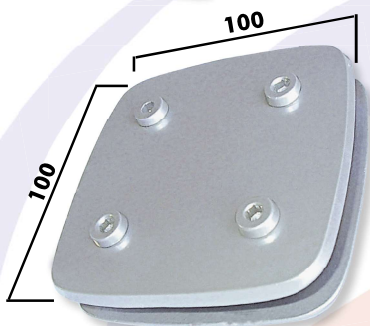
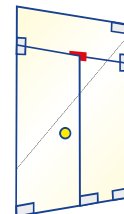

1316

Suporte para União de Quatro Vidros sem Miolo

Disponível em Latão e Zamac

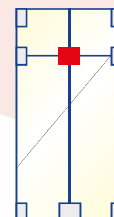

1319

Suporte de Canto para União de Quatro Vidros

Disponível em Latão e Zamac

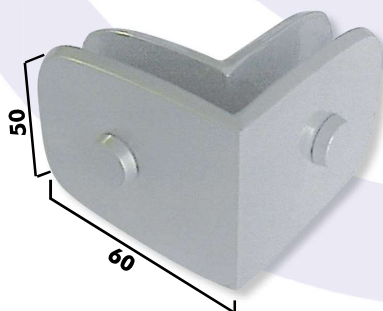
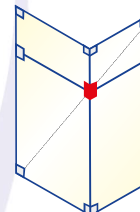

1320

Suporte sem Miolo e Cantoneira Central

Disponível em Latão e Zamac

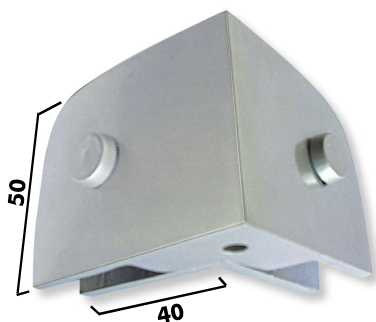
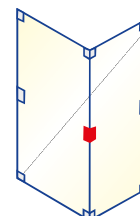

1321

Suporte com Miolo e Cantoneira Inferior/Superior

Disponível em Latão e Zamac

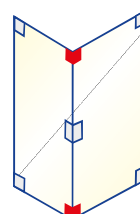

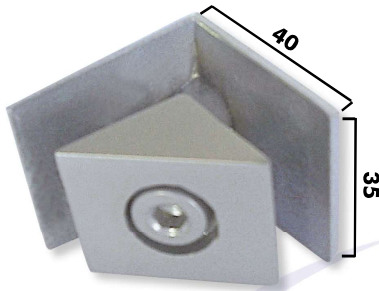

1322
Suporte de Cantoneira Central
Disponível em Latão e Zamac
Vidro - 8mm

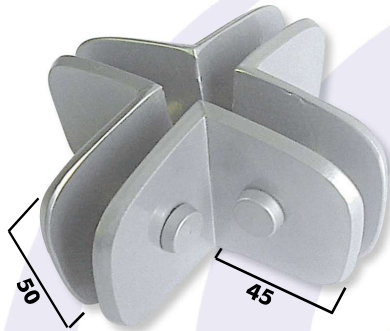
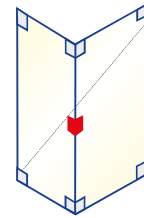

1323
Suporte sem Miolo para União
de Quatro Vidros entre si
Disponível em Latão e Zamac

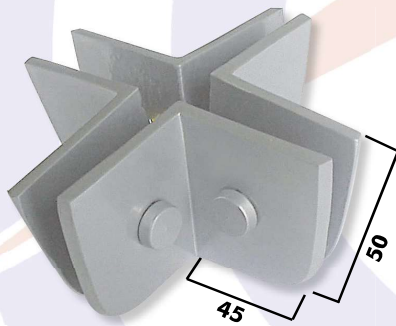
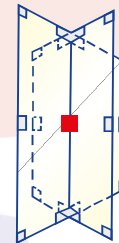

1325
Suporte sem Miolo para União
de Quatro Vidros entre si
Disponível em Latão e Zamac

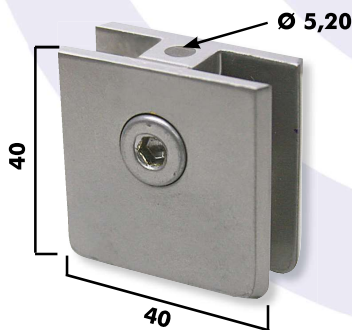
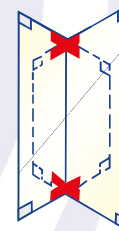

1326
Suporte para Fixação de Vidro
Fixo
Disponível em Latão e Zamac

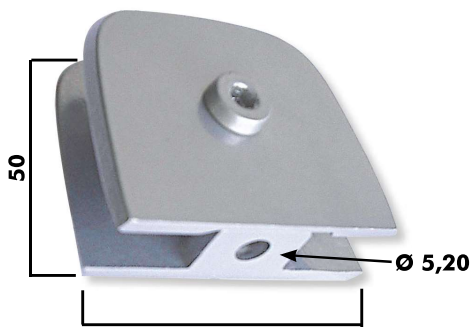
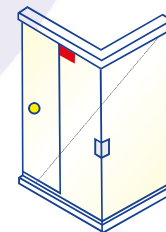

1329
Suporte de Centro
Disponível em Latão e Zamac

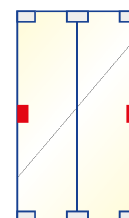

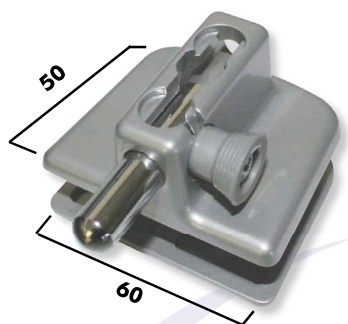

1335
Trinco sem Miolo
Disponível em Latão e Zamac



1335 A
Trinco com Miolo
Disponível em Latão e Zamac

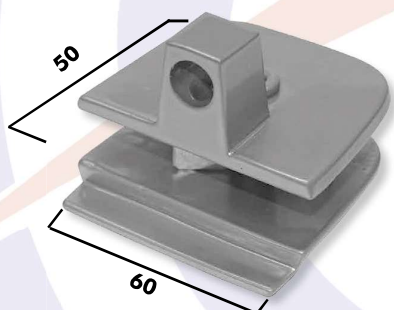
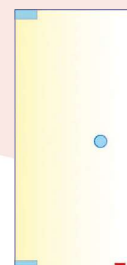

1335 CG
Contra Trinco V/V
Disponível somente em Zamac

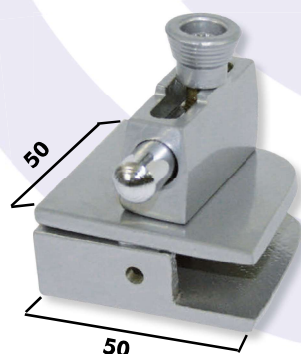
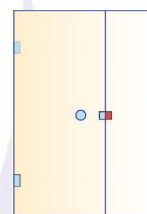

1336 DG
Trinco de Canto com Miolo
Direito
Disponível somente em Zamac

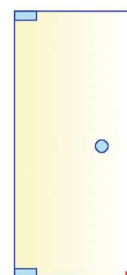

VISTA EXTERNA

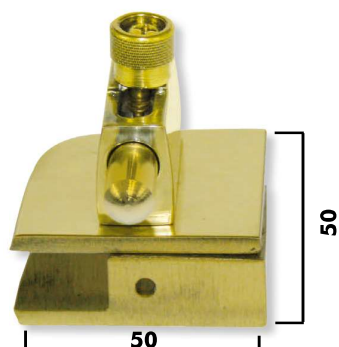

1336 EG
Trinco de Canto com Miolo
Esquerdo
Disponível somente em Zamac

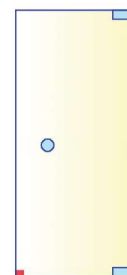

VISTA EXTERNA

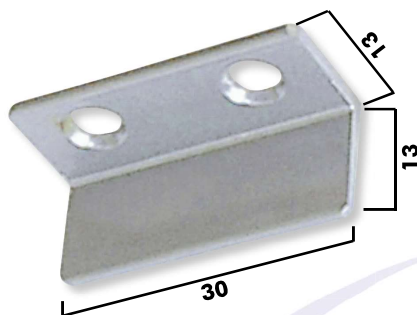

1401
Batedor Simples

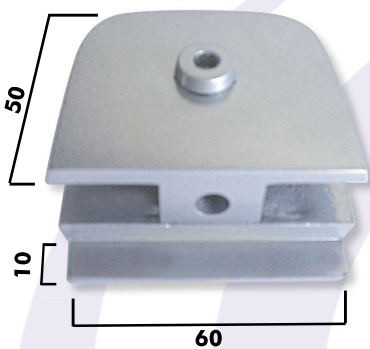
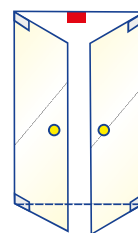

1402
Suporte com Batedor
Disponível em Latão e Zamac

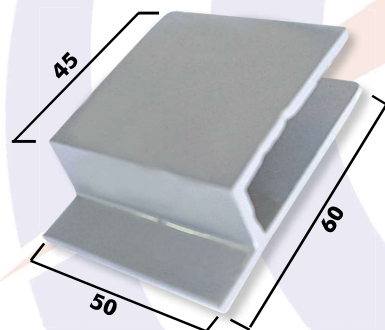
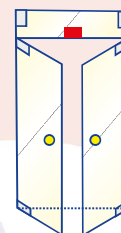

1402 S
Batedeira de Pressão
Vidros de 8mm e 10mm

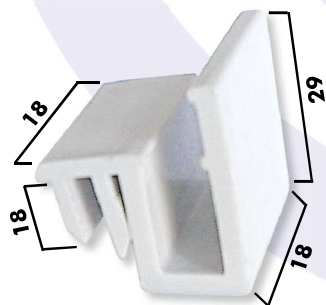
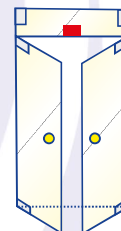

1404
Guia de Delrin para Porta de Correr

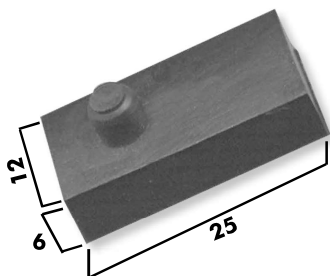
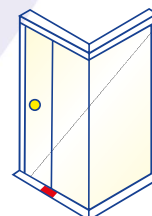

1405
Batedor Retangular de Borracha
para Box

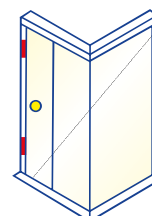

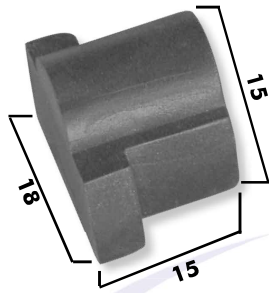

1406
Batedor de Borracha para Box

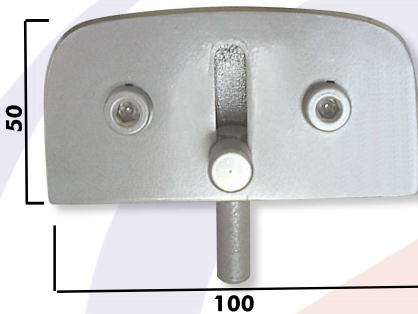
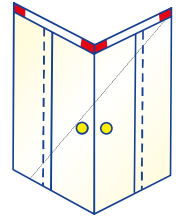

1502
Trinco Inferior com Miolo
Disponível em Latão e Zamac

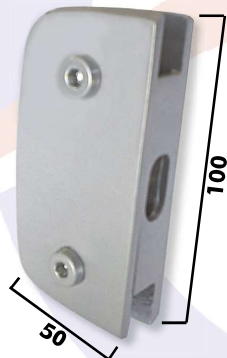
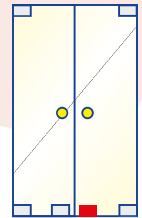

1504
Contra Fechadura com Recorte
para 1520
Disponível em Latão e Zamac

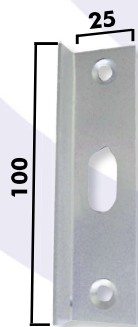
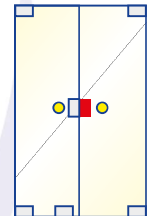

1504 AG
Espelho para fechadura 1520
com aparador
Disponível somente em Zamac

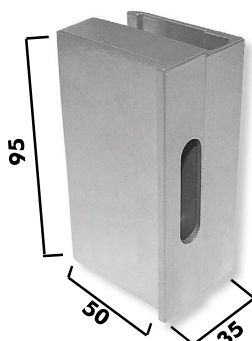
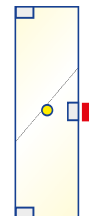

1504 SG
Contra Fechadura de Pressão
para 1520 S G sem aparador
Vidros de 8mm e 10mm
Disponível somente em Zamac

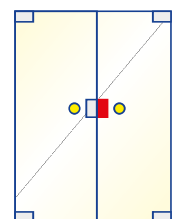

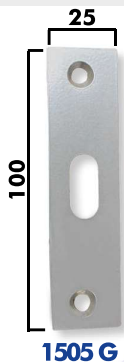

1505 G

1505 G

Espelho para fechadura 1520 sem aparador

Disponível somente em Zamac

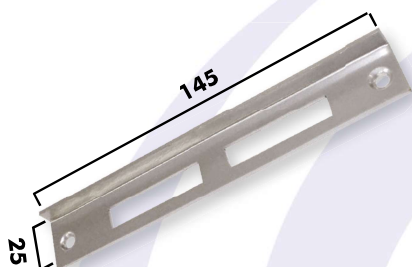
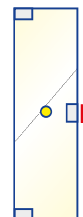

1506 AUG

Contra fechadura alvenaria para 1520 MLG e 1520 MPG

Disponível somente em Zamac



66

1507 G

Contra fechadura para 1520 MLG e 1520 MPG

Disponível somente em Zamac

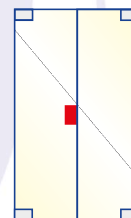

55

1510

Fechadura Bico-de-Papagaio

Disponível em Latão e Zamac

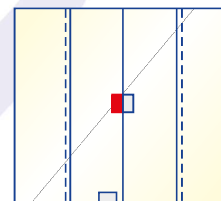

55

1510 D

Fechadura Bico-de-Papagaio para Janela Direita

Disponível em Latão e Zamac

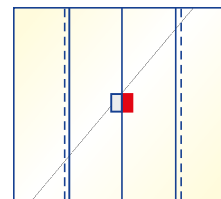

VISTA INTERNA

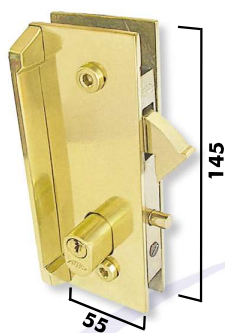

1510 E

Fechadura Bico-de-Papagaio para Janela Esquerda

Disponível em Latão e Zamac

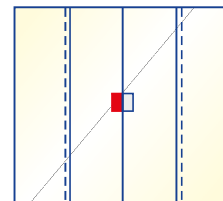

1510 SG

Fechadura de Pressão para Porta de Correr

Vidros de 8mm e 10mm
Disponível somente em Zamac

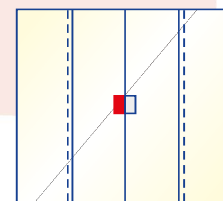

VISTA INTERNA

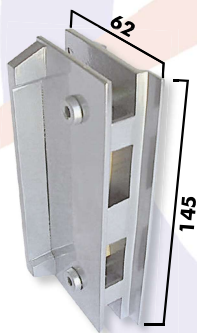

1511

Contra Fechadura para 1510

Disponível em Latão e Zamac

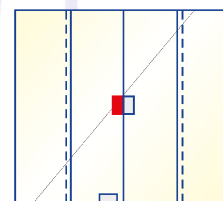

1511 AG

Espelho para 1510 Alvenaria

Disponível somente em Zamac

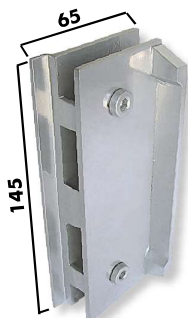
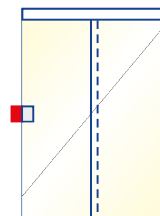

1511 D

Contra Fechadura para 1510 E

Disponível em Latão e Zamac

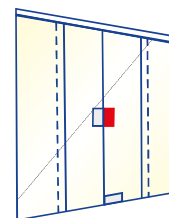

VISTA INTERNA

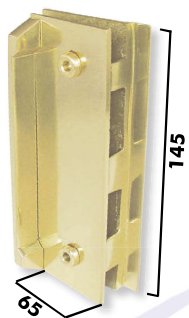

1511 E
Contra Fechadura para 1510 D
Disponível em Latão e Zamac

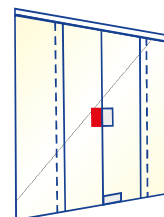

VISTA INTERNA

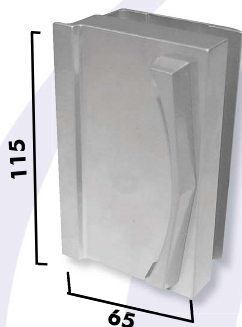

1511 SG
Contra Fechadura VV de Pressão para Porta de Correr
Vidros de 8mm e 10mm
Disponível somente em Zamac

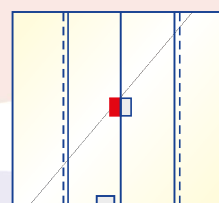

VISTA INTERNA

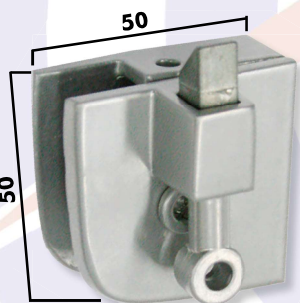

1513
Trinco para Basculante Esquerdo

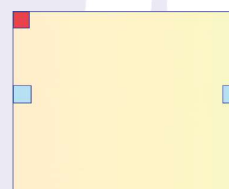

VISTA EXTERNA

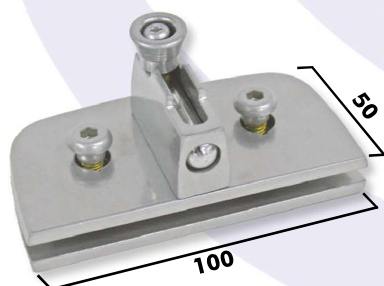

1519
Trinco Inferior sem Miolo
Disponível em Latão e Zamac

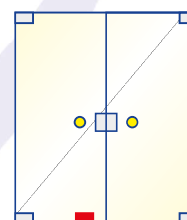

1520
Fechadura para Porta de Abrir
Disponível com Segredo Igual
Disponível em Latão e Zamac

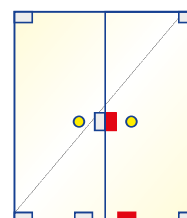

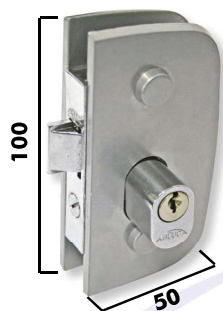

1520 BF

Fechadura para Porta de Abrir
com máquina Bate-Fecha

Disponível em Latão e Zamac
Contra V V 1531BFG - Contra V A 1504ABFG

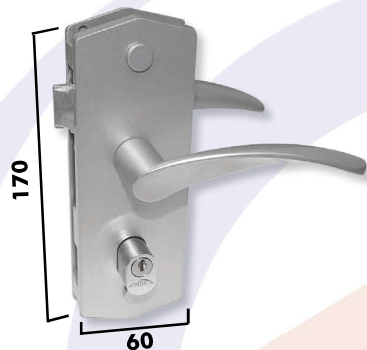
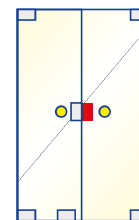

1520 MPG

Fechadura com maçaneta "Fly"
para porta de abrir

Disponível somente em Zamac

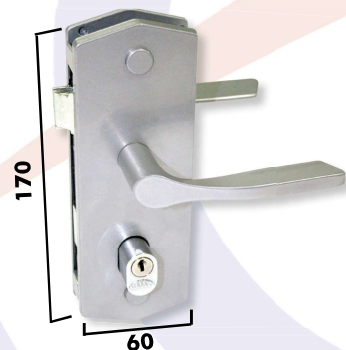
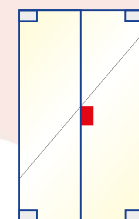

1520 MLG

Fechadura com maçaneta simples
para porta de abrir

Disponível somente em Zamac

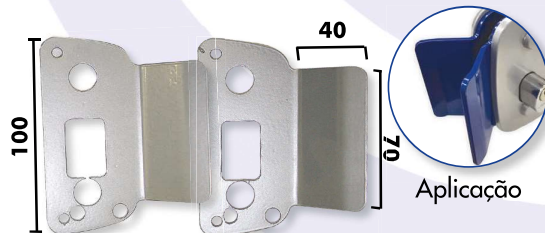
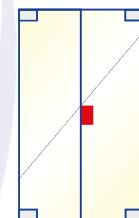

Aplicação

1 PX 520

Puxador para 1520 em aço carbono
montado também na 1531 e 1504
Fechadura não acompanha
o puxador

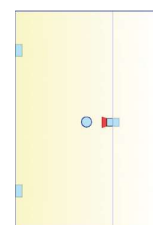

1520 SG

Fechadura de Pressão Central
para Porta de Abrir

Vidros de 8mm e 10mm
Disponível somente em Zamac

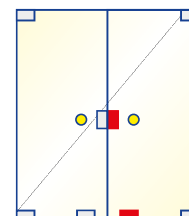

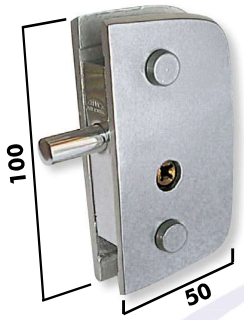

1520 TT
Fechadura Chave Multiponto

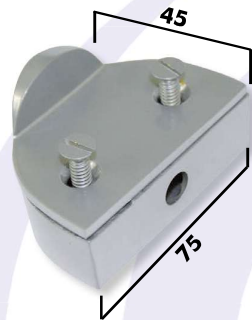
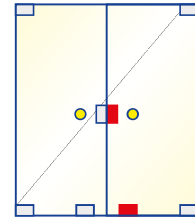

1521
Contra Trinco VV para Trinco
1527 com Puxador Externo

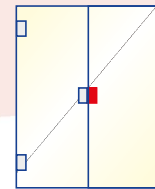

1521

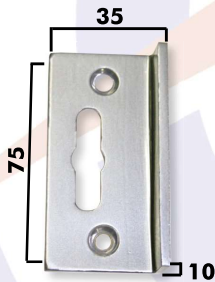

1521 A
Contra Trinco VA para Trinco
1527

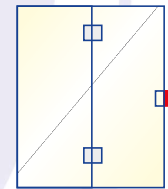

1521 A

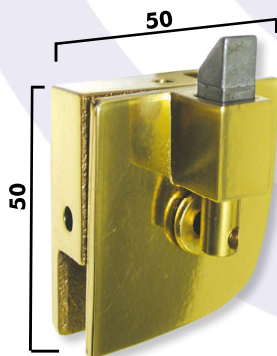

1522
Trinco para Basculante
Direito

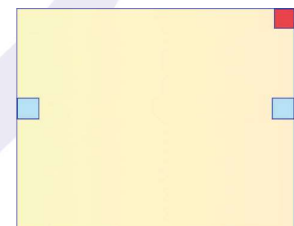

VISTA EXTERNA

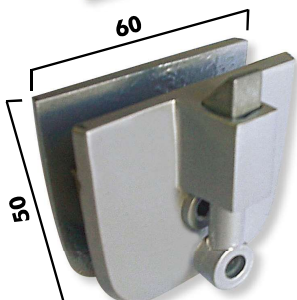

1523
Trinco Central para Basculante
Disponível em Latão e Zamac

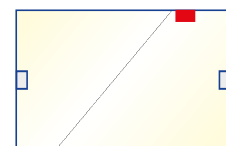

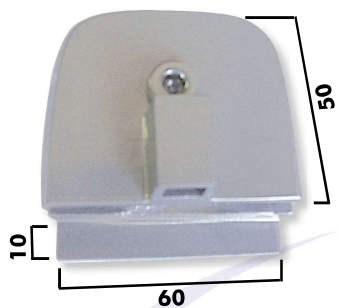

1524
Contra Trinco Central para
Basculante V/V
Disponível em Latão e Zamac

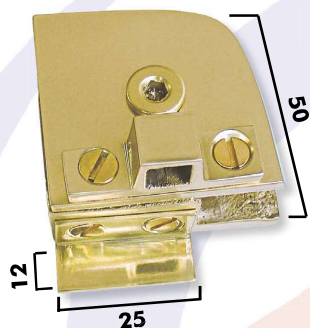
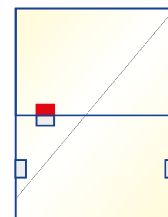

1525
Contra Trinco Esquerdo para
Basculante

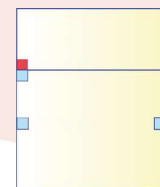

VISTA EXTERNA

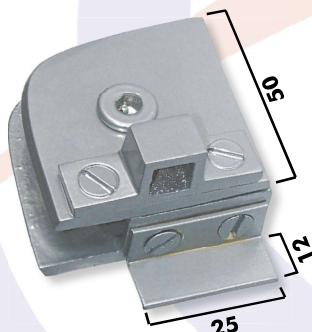

1526
Contra Trinco Direito para
Basculante

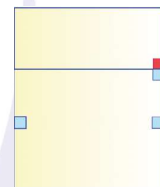

VISTA EXTERNA

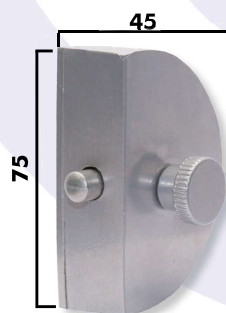

1527
Trinco para Porta de Abrir
com 1 rolete apenas e
Puxador externo

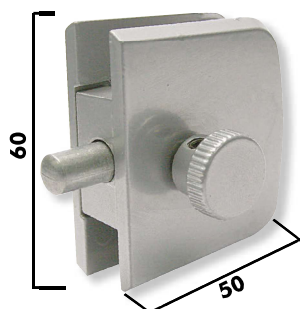
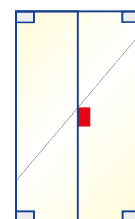

1529G
Trinco para Box de Abrir
(com roletes dos dois lados)
Disponível somente em Zamac

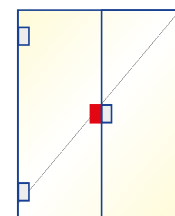

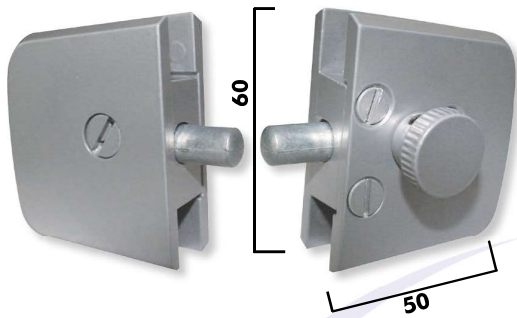

1529-1G
Trinco para Box de Abrir
com 1 rolete apenas
Disponível somente em Zamac

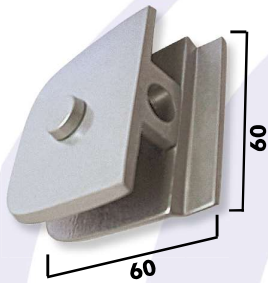
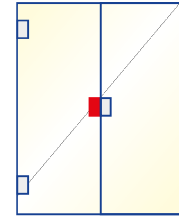

1530G
Contra Trinco para Box
de Abrir
Disponível somente em Zamac

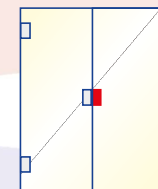

1530 AG
Espelho para Trinco 1529
para Alvenaria
Disponível somente em Zamac

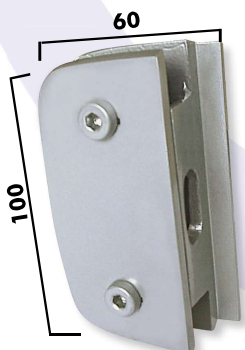
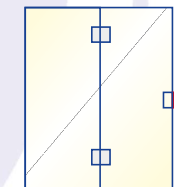

1531
Contra Fechadura com
Aparador para 1520
Disponível em Latão e Zamac

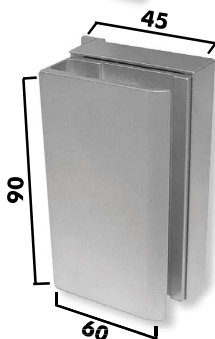
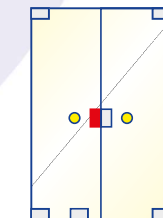

1531 SG
Contra Fechadura de Pressão
VV para Porta de Abrir

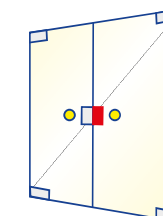

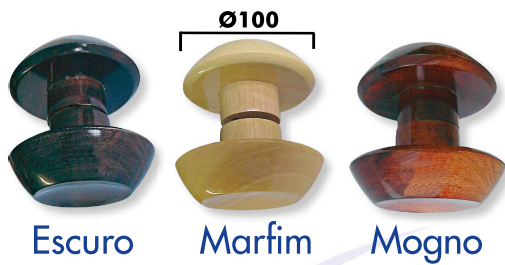

1607

Puxador de Madeira

Códigos: 607 EC Escuro
607 MF Marfim
607 MG Mogno

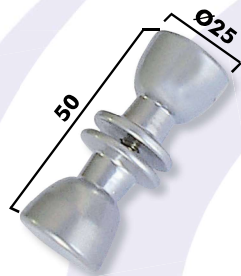
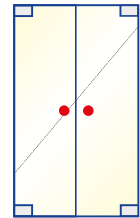

1629 A

Puxador de Latão com 22 mm de Diâmetro

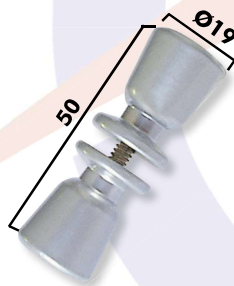
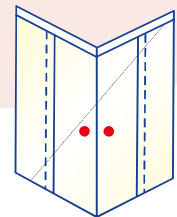

1629 BG

Puxador com 19 mm de Diâmetro

Disponível somente em Zamac

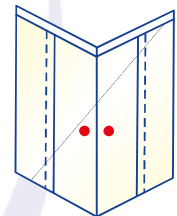

1629 JG

Puxador de Janela com 19 mm de Diâmetro

Disponível somente em Zamac

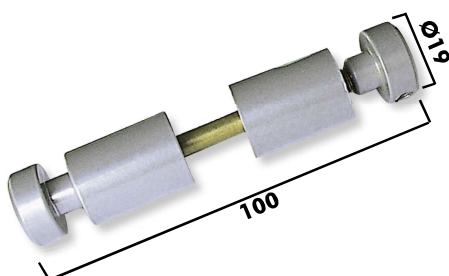
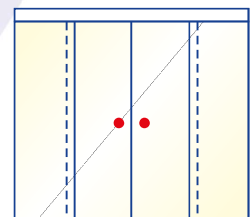

1636

Prolongador para Puxador de Vidro

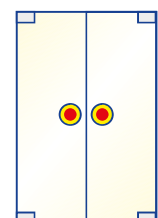

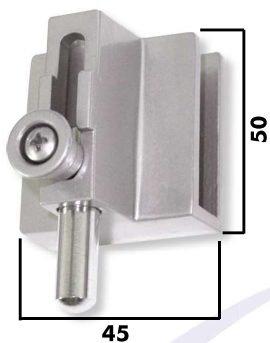

45

1800 G

Trinco de Pressão para Porta de Abrir

Disponível somente em Zamac
Vidros de 8mm e 10mm

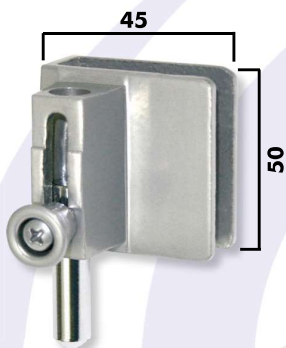
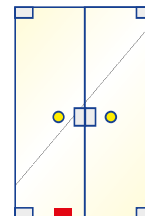

45

1800 A

Trinco de Pressão para Porta de Correr

Vidros de 8mm e 10mm

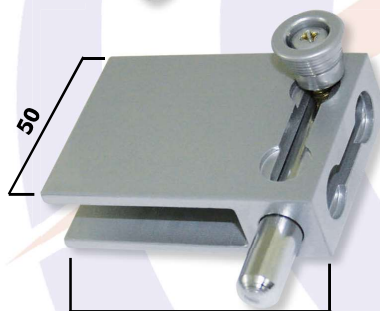
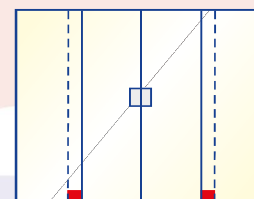

50

65

1800 ATG

Trinco de Pressão para Porta de Correr

Disponível somente em Zamac
Vidros de 8mm e 10mm

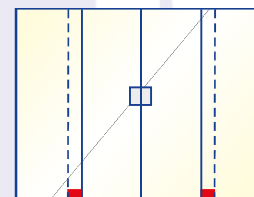

50

65

1800 FG

Trinco com Parafuso para Porta de Correr

Disponível somente em Zamac

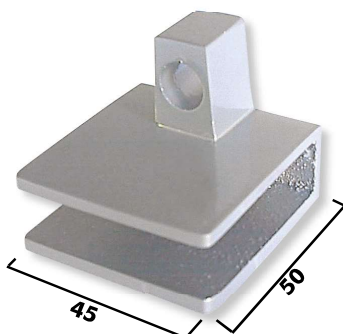
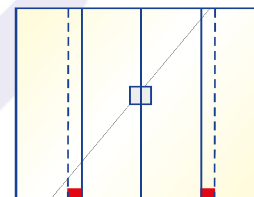

45

50

1800 C

Contra Trinco de Pressão V/V

Vidros de 8mm e 10mm

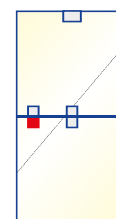

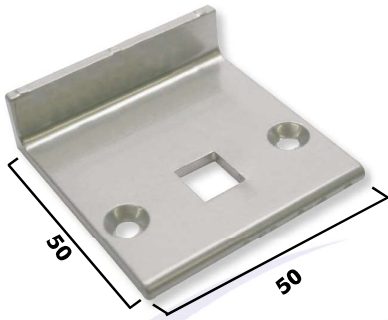

1801 G
Chapinha para Trinco Basculante
Disponível somente em Zamac

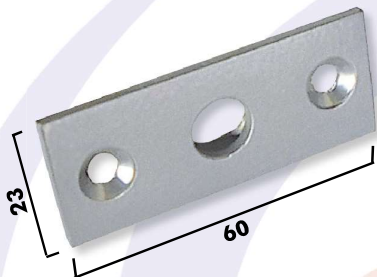
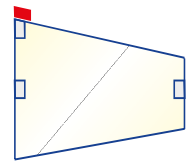

1801 CG
Chapinha para Trinco de Piso
Disponível somente em Zamac

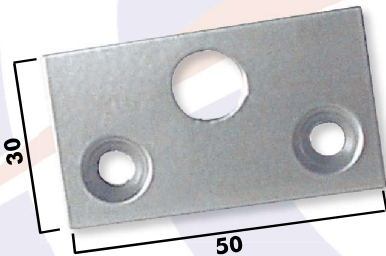
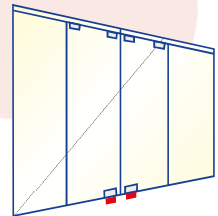

1801 D
Chapinha para Trinco de Porta
de Correr com Furo Deslocado

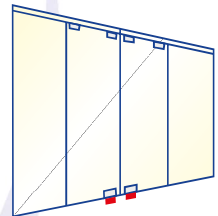

1871 G
Fixador de Porta para Rodapé
e Piso de Pressão
Disponível somente em Zamac

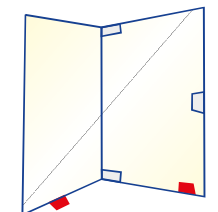

1871 FG
Fixador de Porta para Piso e
Rodapé com furo padrão 1335
Disponível somente em Zamac

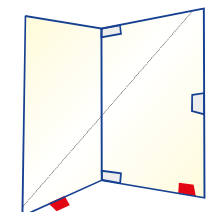

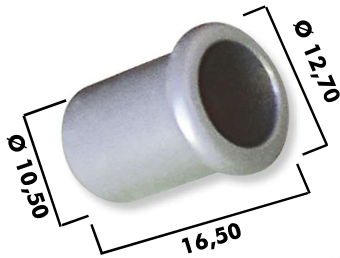

1037
Capuchinho Furo 9MM

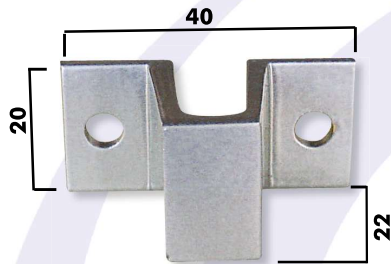
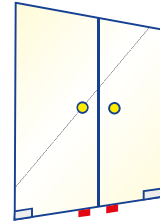

1038 BM
Capuchinho para Trinco 1335MG
Trilho Exposto Mini

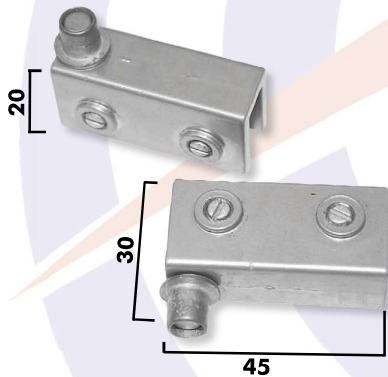
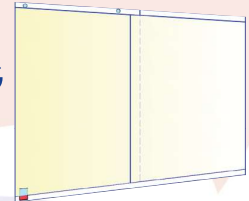

1101 MG
Dobradiça para Rack Superior
e Inferior Mini de Pressão
Montagem em vidros de 8 e 6mm
Disponível somente em Zamac
Dimensões máximas recomendadas
350x650mm

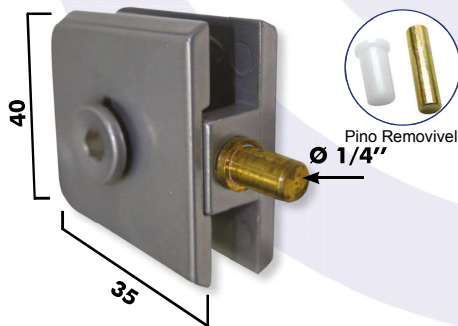
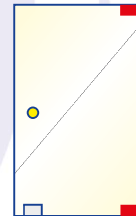

1123 MG
Dobradiça para Vidro
Basculante Mini
Disponível somente em Zamac
Dimensões máximas recomendadas
400x400mm - 8mm
 $X = \frac{(48.000 / A) + B}{2}$

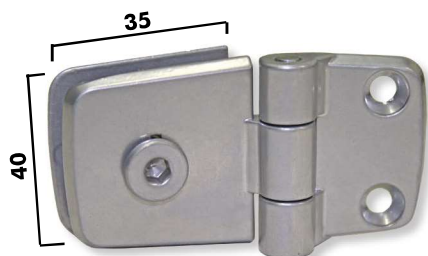
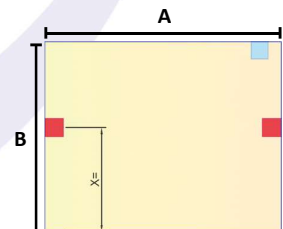

1136 MG
Dobradiça Lateral Horizontal
Mini
Disponível somente em Zamac
Dimensões máximas recomendadas
400x600mm - 8mm
Indicado lubrificação periódica no pino

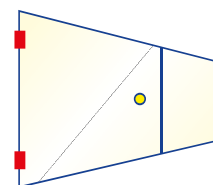

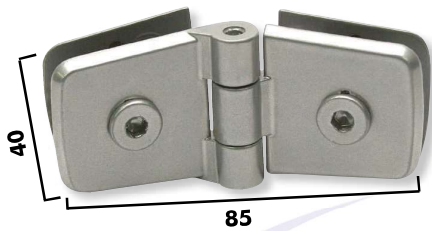

1137 MG

Dobradiça Horizontal Dupla Mini

Disponível somente em Zamac
Dimensões máximas recomendadas
400x600mm - 8mm
Indicado lubrificação periódica no pino

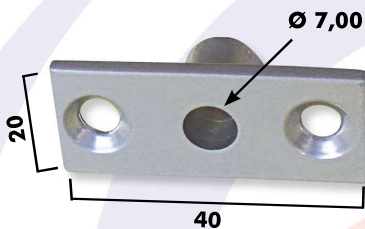
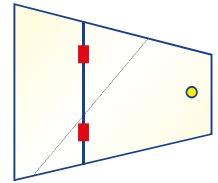

1201 M

Bucha para Pivô de Dobradiça Mini

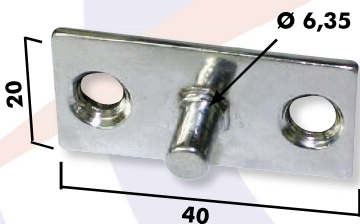
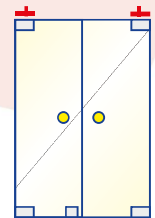

1201 MS

Bucha para Pivô de Dobradiça 1230 M

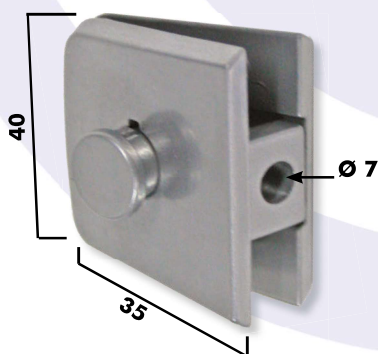
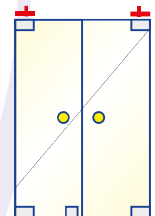

1230 MG

Suporte para Basculante Mini

Disponível somente em Zamac
Dimensões máximas recomendadas
400x400mm - 8mm
 $X = \frac{(48.000 / A) + B}{2}$

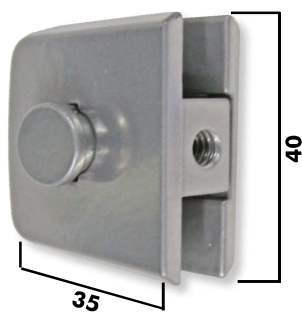
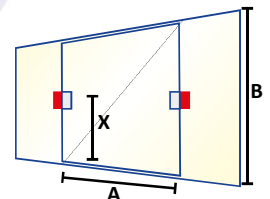

1329 MG

Suporte de Centro Mini

Disponível somente em Zamac

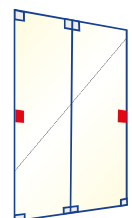

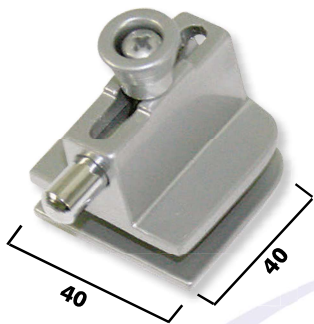

1335 MG
Trinco sem Miolo Mini
Disponível somente em Zamac

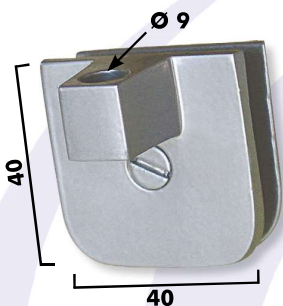
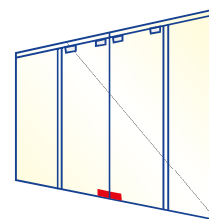

1335 CM
Contra-trinco V/V Mini

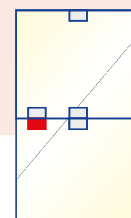

1520 R
Fechadura para Rack Pressão
Porta Simples Mini
Montagem em vidros de 8 e 6mm
Disponível somente no acabamento cromado

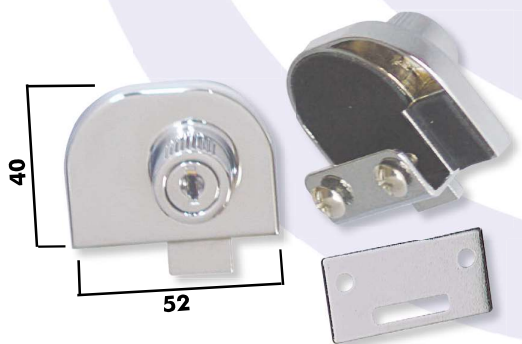
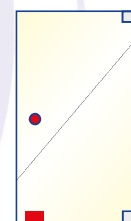

1520 RD
Fechadura para Rack Pressão
Porta Dupla Mini
Montagem em vidros de 8 e 6mm
Disponível somente no acabamento cromado

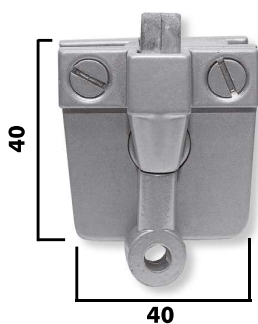
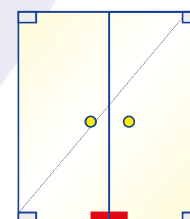

1523 MG
Trinco Central para Basculante
Mini
Disponível somente em Zamac

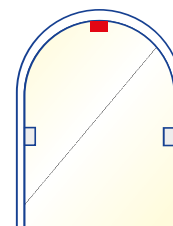

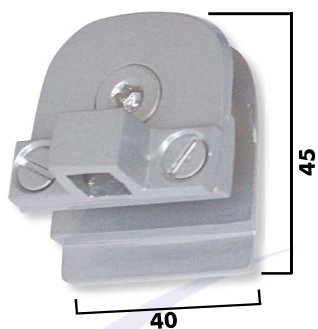

1524 MG

Contratrinco Central para
Basculante V/V Mini

Disponível somente em Zamac

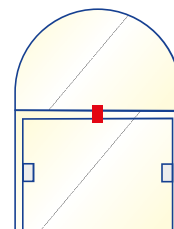

1629 JM

Puxador de Latão para Rack
Mini

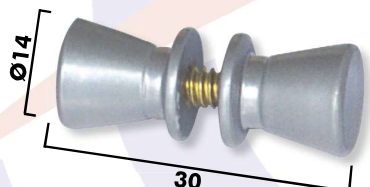
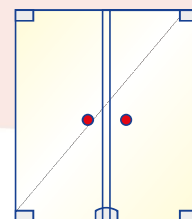

1629 M

Puxador de Latão Mini

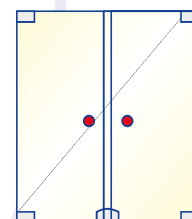

1800 M

Trinco de Pressão Porta de Abrir
Mini

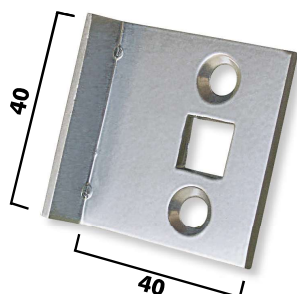
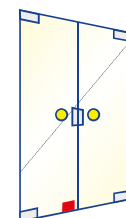

1801 M

Chapinha para Trinco
Basculante Mini



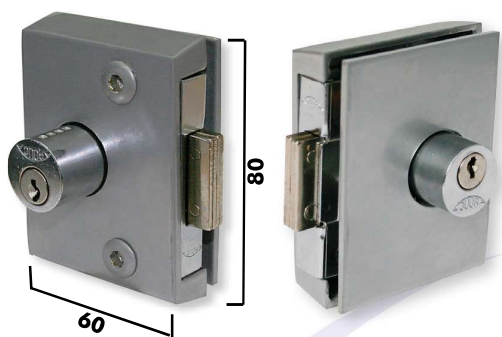

3210 M
Fechadura de Centro Mini

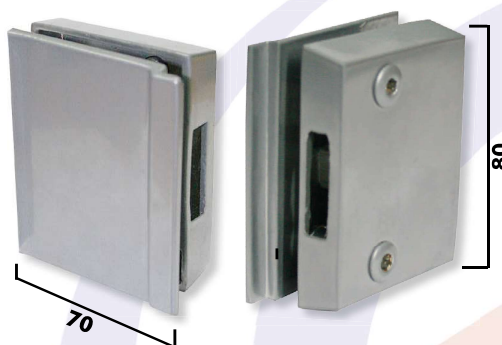
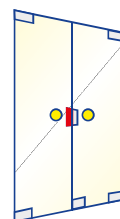

3211 M
Contra Fechadura com
Aparador Mini (para 3210 M)

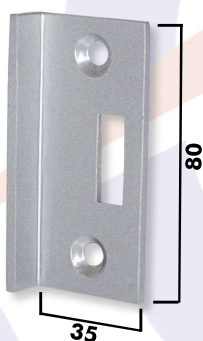
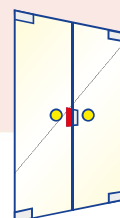

3230 MG
Espelho para Fechadura
com Aparador para 3210M,
3530M e 3532M
Disponível somente em Zamac

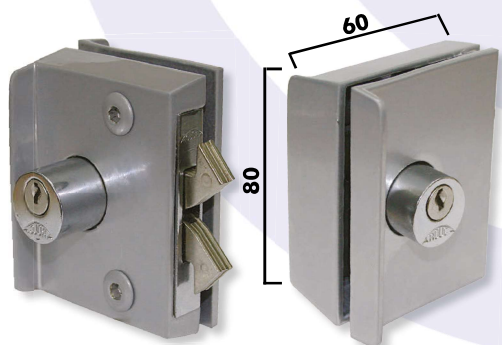
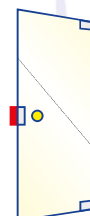

3530 MG
Fechadura Mini para Porta
de Correr

Disponível somente em Zamac

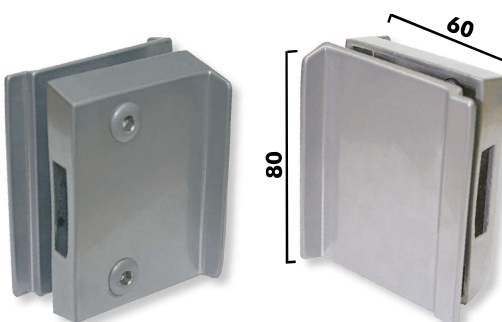
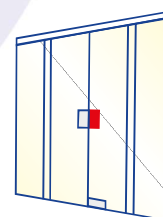

3534 MG
Contra Fechadura Mini
para Porta de Correr

Disponível somente em Zamac

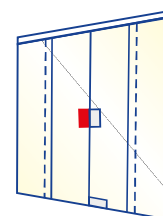

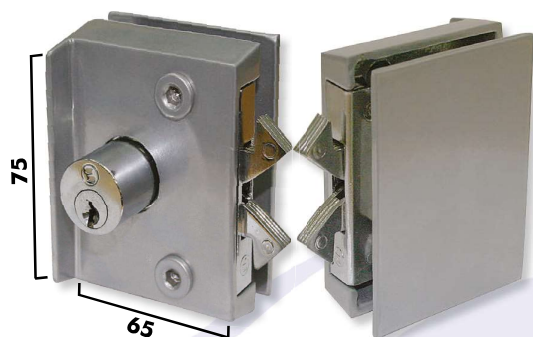

3532 JMG

Fechadura Mini para Janela de Correr sem Cilindro Externo

Disponível somente em Zamac

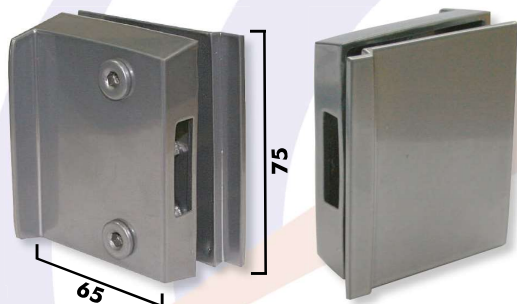
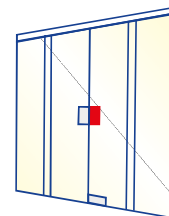

3536 JMG

Contra Fechadura sem Puxador Externo Mini

Disponível somente em Zamac

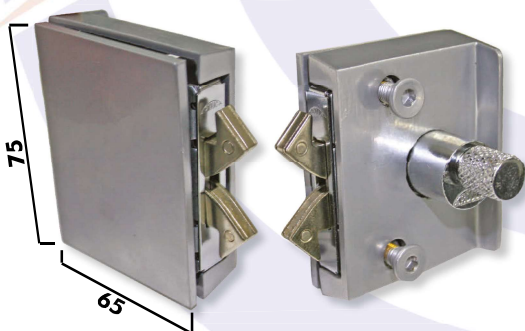
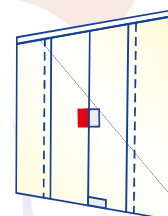

3535 G

Trinco Mini para Janela de Correr

Disponível somente em Zamac

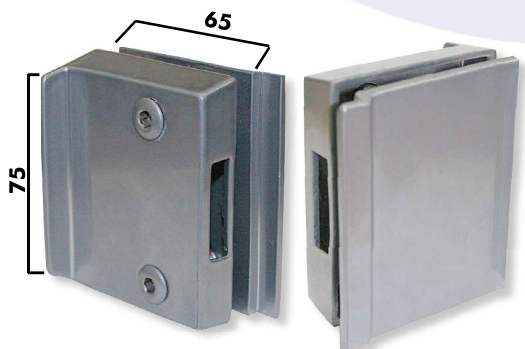
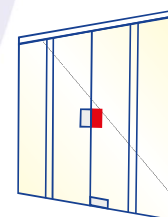

3434G

Contra Trinco Mini VV para Janela de Correr

Disponível somente em Zamac

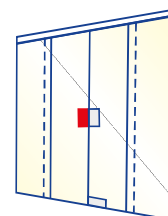

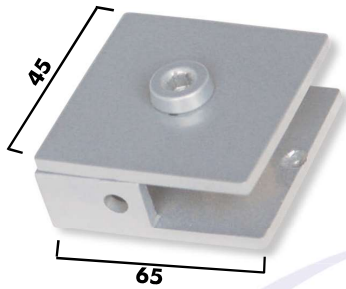

2009
Suporte Simples de Canto

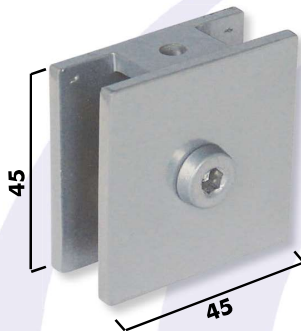
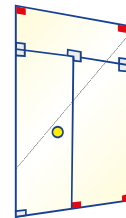

2010
Suporte Simples de Centro

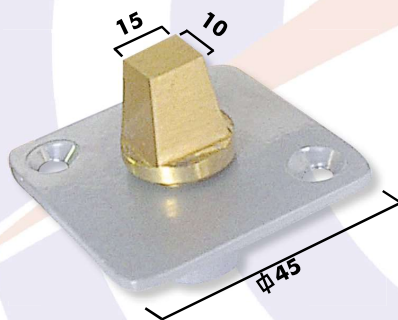
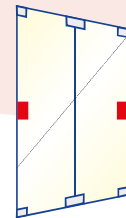

2105
Mancal Inferior para Dobradiça Porta

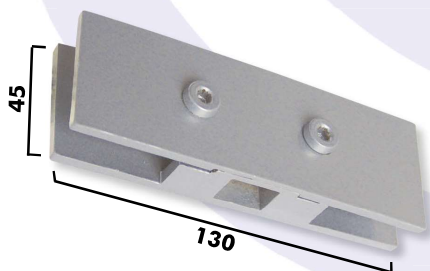
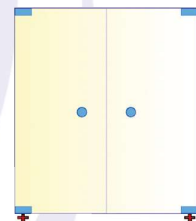

2110
Dobradiça Inferior
Dimensões máximas recomendadas
1000x2200mm ou 900x2600mm

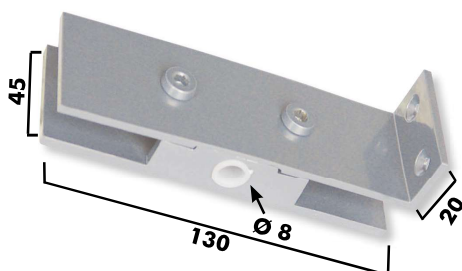
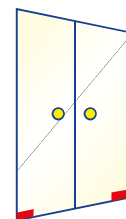

2122
Suporte de Batente para Dobradiça 2140

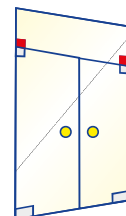

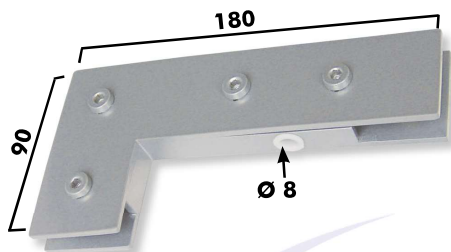

2132 / 2133

Suporte para dobradiça 2110 com Fixo e Bandeira

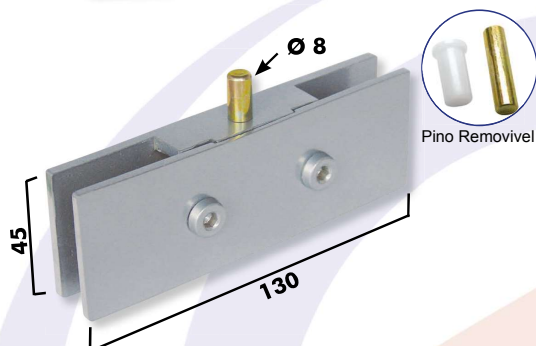
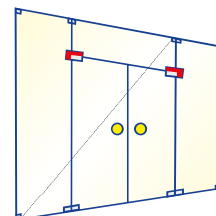

2140

Dobradiça Superior Simples

Dimensões máximas recomendadas
1000x2200mm ou 900x2600mm

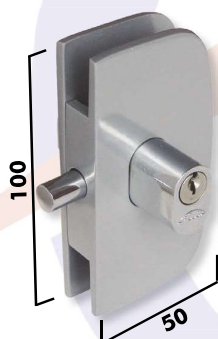
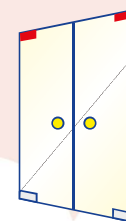

2210

Fechadura de Centro e Piso

Disponível somente acabamento cromado

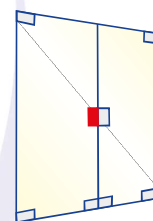

2210 GRD

Fechadura de Centro Grande
50x170

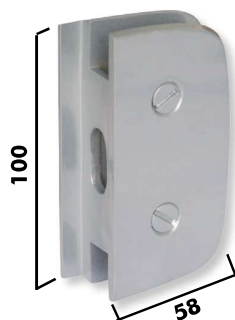
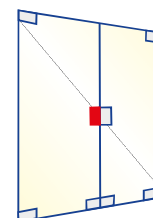

2211

Contra VV para fechadura 2210 com Aparador

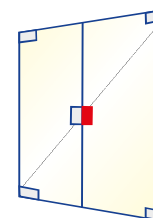

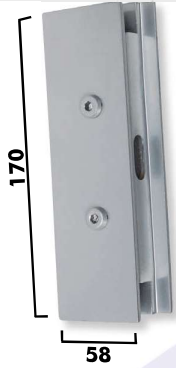

2211 GRD
Contra Fechadura Grande
50x170

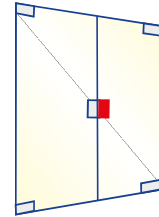

2212G
Espelho para Fechadura com
Aparador
Disponível somente em Zamac

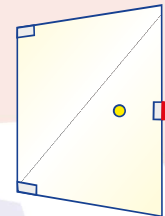

2212 AG
Espelho para Fechadura sem
Aparador
Disponível somente em Zamac

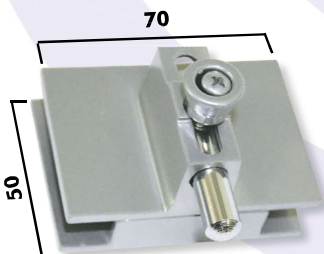
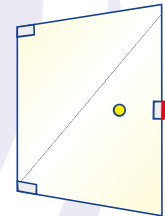

2240 / 2241
Trinco para Porta de Abrir

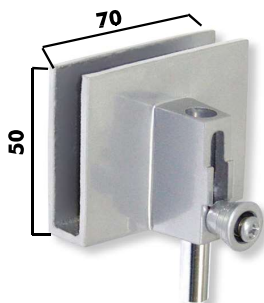
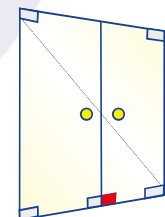

2242
Trinco de Pressão
Vidros de 8mm e 10mm

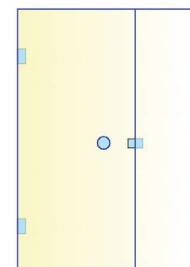

2242



2245

Pino de Trava para Trinco de Pressão

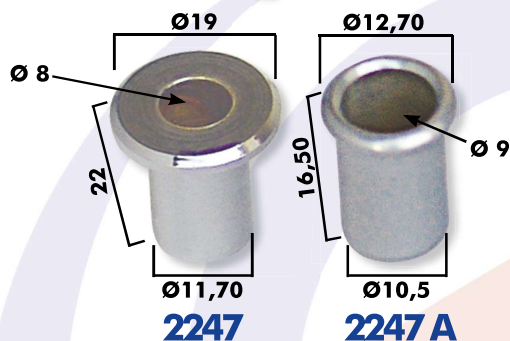

2247

Contra Trinco para 2245

2247 A

Contra Trinco para 2240 / 2241 / 2242

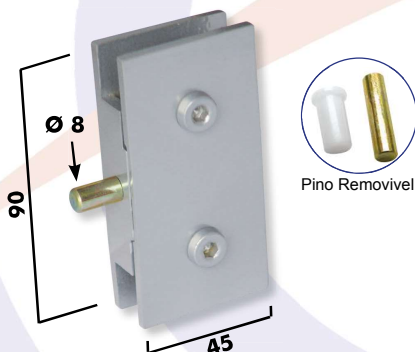
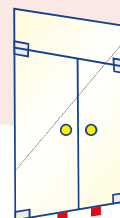

2401

Suporte Central para Janela Basculante e Pivot

Dimensões máximas recomendadas 1000x800mm

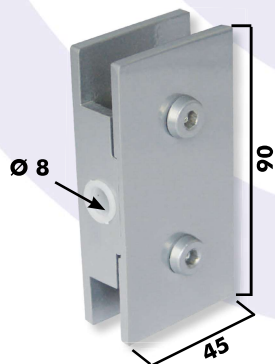

2402

Suporte Central para Janela Basculante e Pivot

Dimensões máximas recomendadas 1000x800mm

$$X = \frac{(48.000 / A) + B}{2}$$

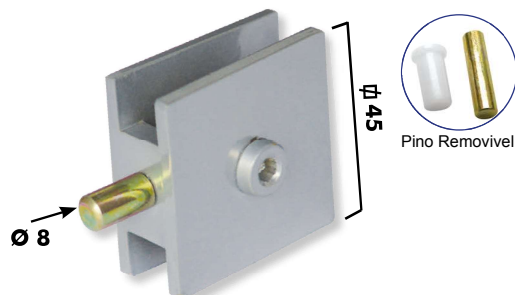
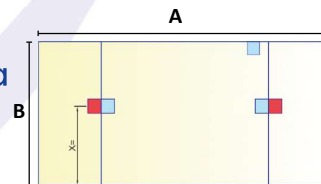

2405

Suporte Simples Central para Janela Basculante

Dimensões máximas recomendadas 800x700mm

$$X = \frac{(48.000 / A) + B}{2}$$

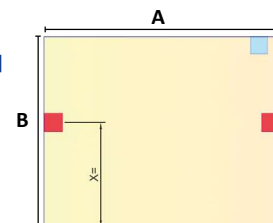

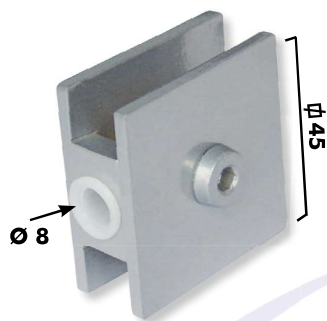

2406

Suporte Simples Central para Janela Basculante

Dimensões máximas recomendadas
800x700mm

$$X = \frac{(48.000 / A) + B}{2}$$

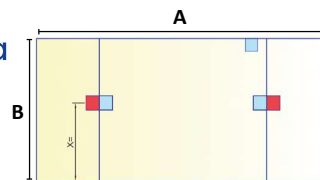

2410

Trinco com Corrente para Janela Basculante (Completo)

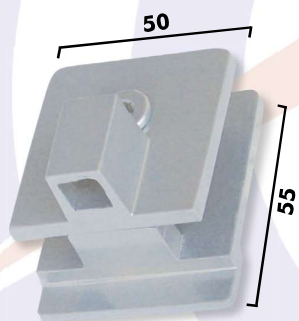
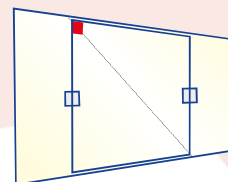

2411

Contra Trinco de Centro com Aparador

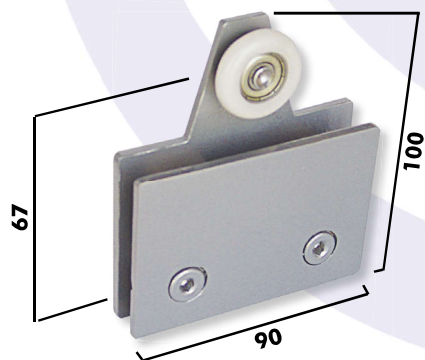
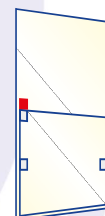

2520

Carrinho para Porta de Correr

Dimensões máximas recomendadas
600x1800mm - Vidro 8mm

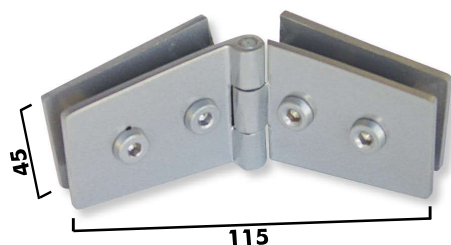
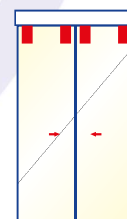

2701

Dobradiça Dupla para Box

Dimensões máximas recomendadas
600x1900mm

Indicado lubrificação periódica no pino

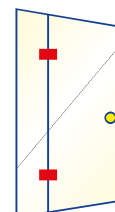

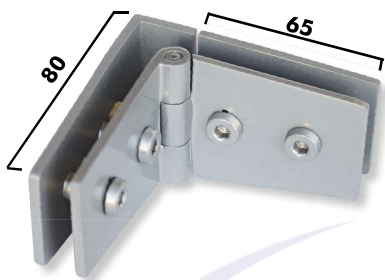

2702 Dobradiça Dupla de Canto

Dimensões máximas recomendadas
600x1900mm
Indicado lubrificação periódica no pino

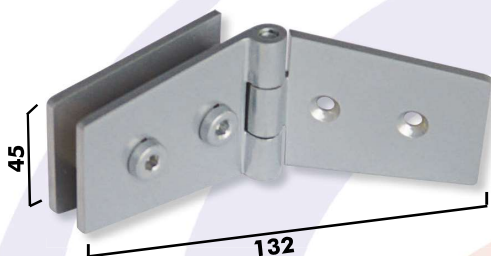
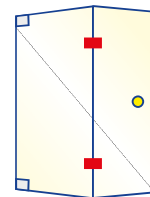

2703 Dobradiça de Box com Aba Larga

Dimensões máximas recomendadas
600x1900mm
Indicado lubrificação periódica no pino

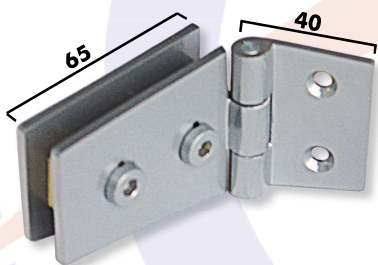

2704 / 2705 Dobradiça de Box com Giro Interno / Externo

Dimensões máximas recomendadas
600x1900mm
Indicado lubrificação periódica no pino

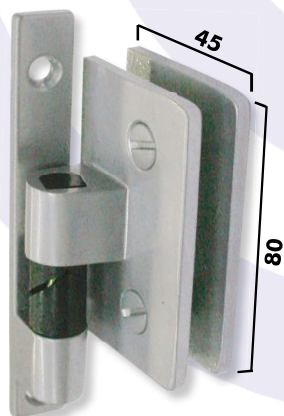

2708 Dobradiça automática para Box

Dimensões máximas recomendadas
600x1900mm - Vidro 8mm

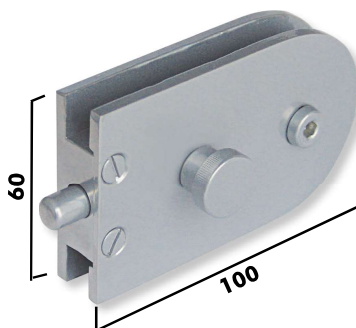

2720 Trinco com Puxador de Metal para Box

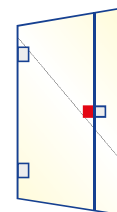

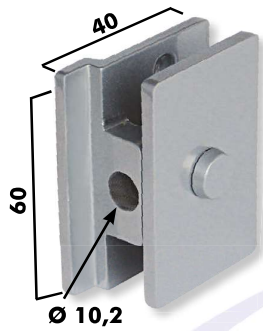

2721
Contra Trinco com Aparador
Externo

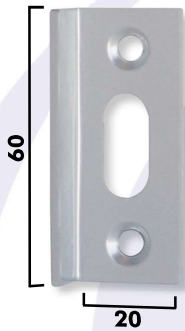
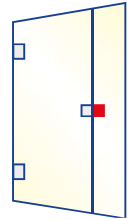

2723G
Espelho para Trinco de Box
Disponível somente em Zamac

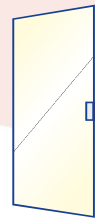

2730
Cantoneira Central de Box

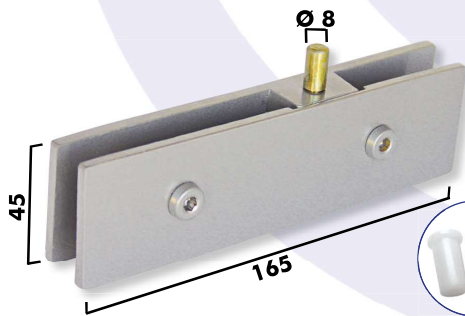
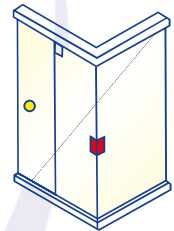

Pino Removível

72 A - Linha 1000
Dobradiça Superior

Dimensões máximas recomendadas
1000x2200mm ou 900x2600mm

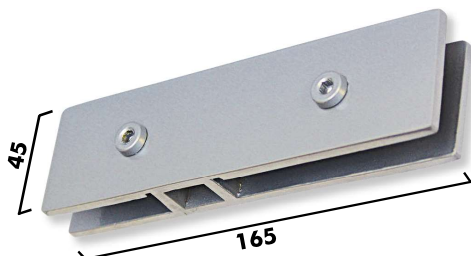
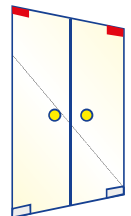

72 B - Linha 1000
Dobradiça Inferior

Dimensões máximas recomendadas
1000x2200 ou 900x2600mm

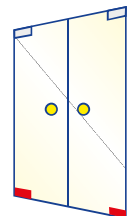

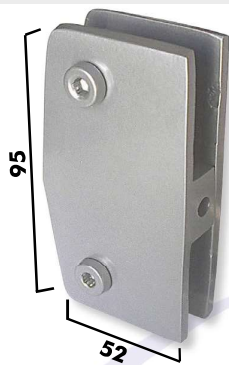

3001
Suporte Duplo Vertical
Disponível em Latão e Zamac

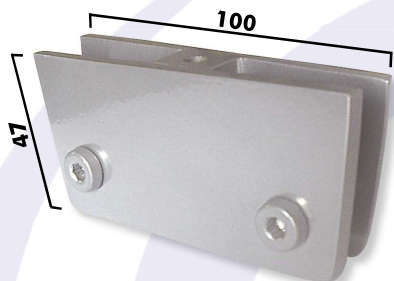
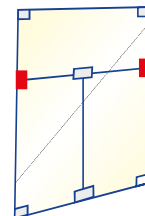

3002
Suporte Duplo Horizontal
Disponível em Latão e Zamac

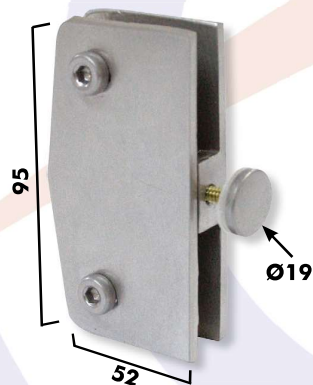
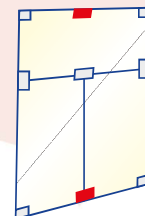

3003
Suporte Duplo Horizontal
com Capuchinho
Disponível em Latão e Zamac

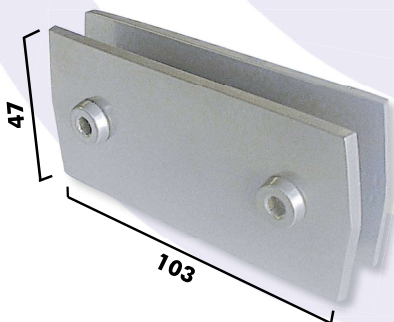
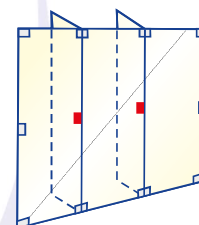

3004
Suporte Duplo Central

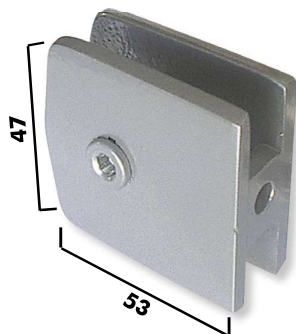
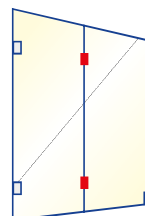

3006
Suporte Simples Vertical
Disponível em Latão e Zamac

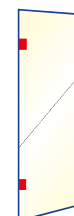

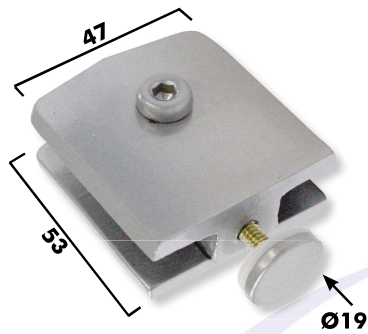

3007
Suporte Simples Vertical com Capuchinho

Disponível em Latão e Zamac

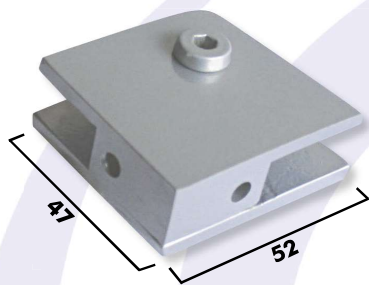
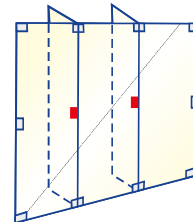

3009
Suporte Simples de Canto

Disponível em Latão e Zamac

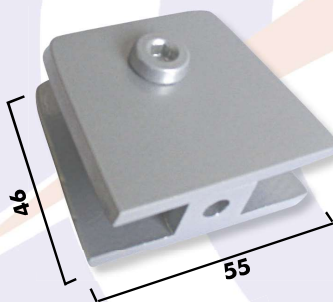
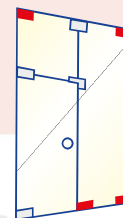

3010
Suporte Simples de Centro

Disponível em Latão e Zamac

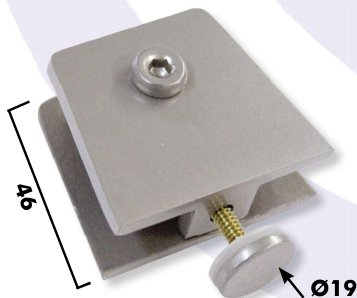
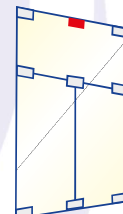

3013
Suporte de Centro com Capuchinho

Disponível em Latão e Zamac

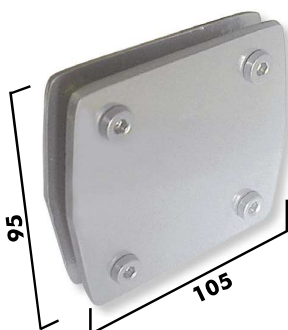
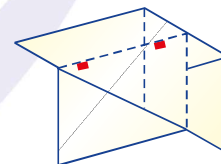

3014
Suporte Quádruplo

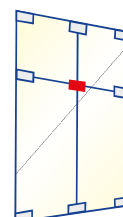

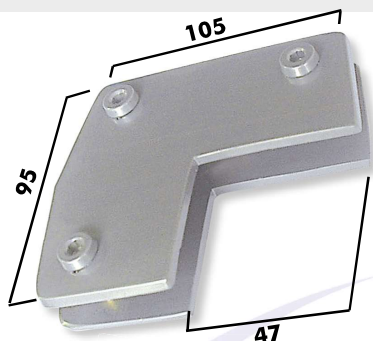

3016
Suporte Triplo

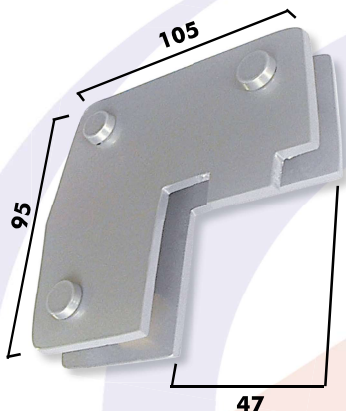
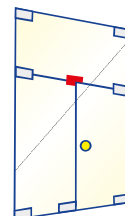

3017
Suporte Triplo com Aparador Reversível

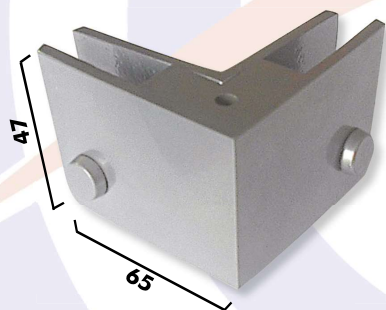
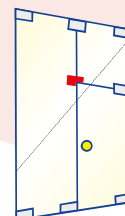

3022
Cantoneira com Núcleo

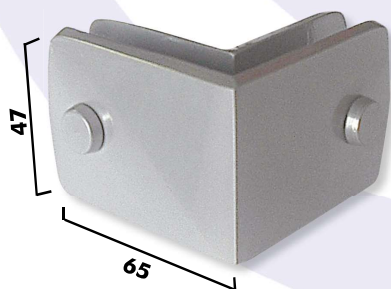
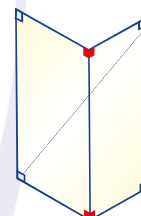

3023
Cantoneira sem Núcleo

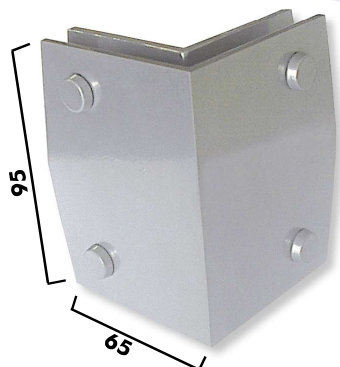
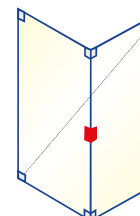

3025
Cantoneira Quádruplo

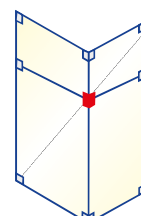

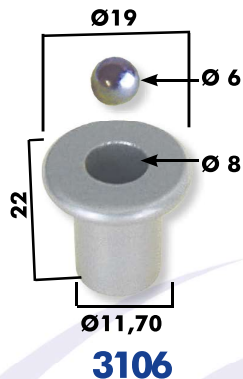
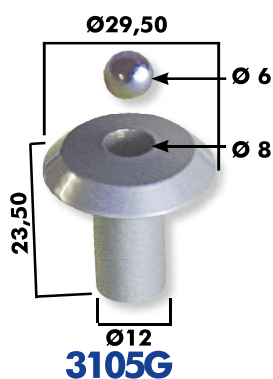

3105 G

Mancal Inferior para
Dobradiça 3140
Disponível somente em Zamac

3106

Mancal Inferior para
Dobradiça Pivotante 3141

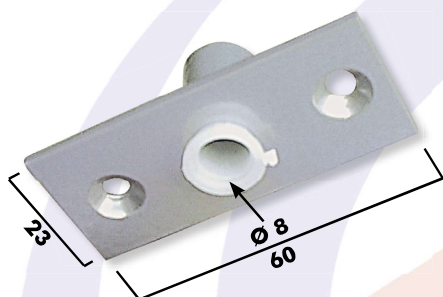
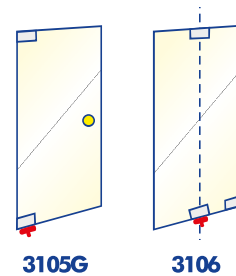

3107 G

Mancal Superior e Lateral
Retangular
Disponível somente em Zamac

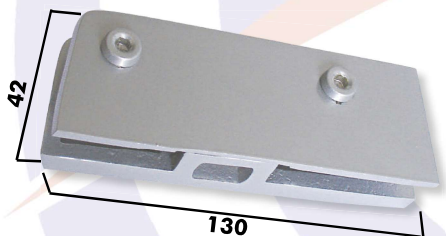

3110

Dobradiça inferior (para mola)
Dimensões máximas recomendadas
1200x2200mm ou 900x2600mm

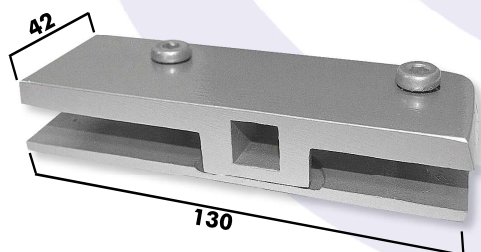
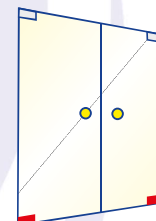

3110 SM

Dobradiça inferior
com encaixe Santa Marina
Dimensões máximas recomendadas
1200x2200mm ou 900x2600mm

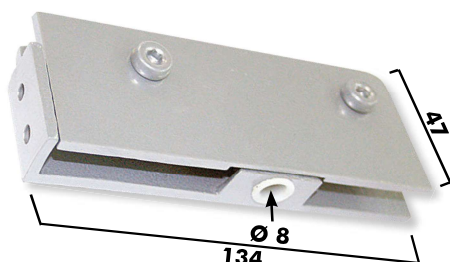
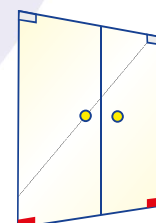

3122

Suporte de Batente

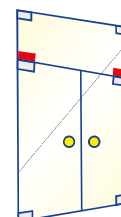

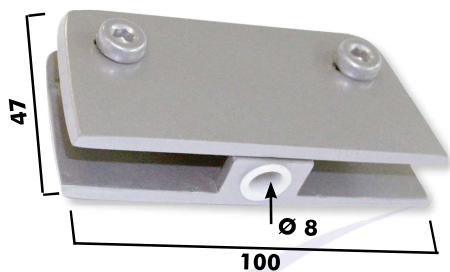

3123

Suporte para Dobradiça 3141
Porta Pivotante

Disponível em Latão e Zamac

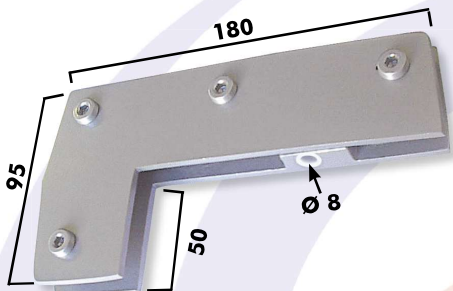
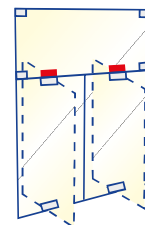

3132

Suporte "L" para Dobradiça 3140

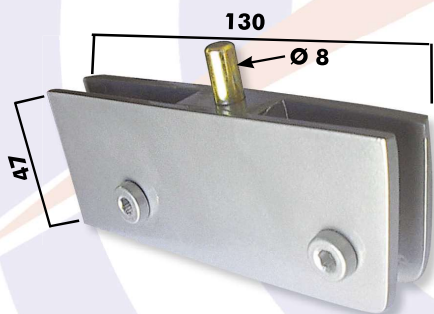
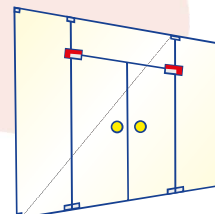

Pino Removível

3140

Dobradiça Superior e Inferior
(para porta sem mola)

Disponível em Latão e Zamac
Dimensões máximas recomendadas
1200x2200mm ou 900x2600mm

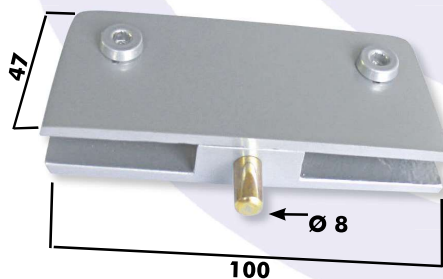
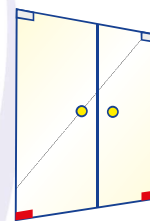

Pino Removível

3141

Dobradiça para Porta Pivotante

Dimensões máximas recomendadas
900x2100mm

Disponível em Latão e Zamac

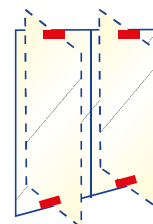

3143

Dobradiça Vidro/Vidro

Disponível em Latão e Zamac
Dimensões máximas recomendadas
800x2100mm
Indicado lubrificação periódica no pino

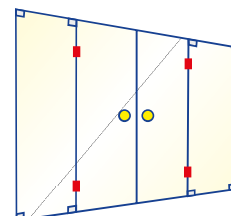

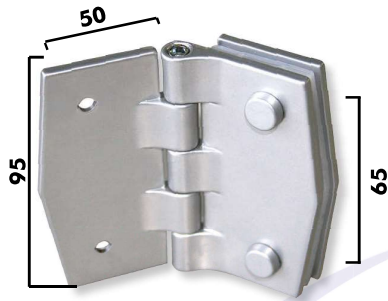

3144

Dobradiça de Batente

Disponível em Latão e Zamac
Dimensões máximas recomendadas
800x2100mm
Indicado lubrificação periódica no pino

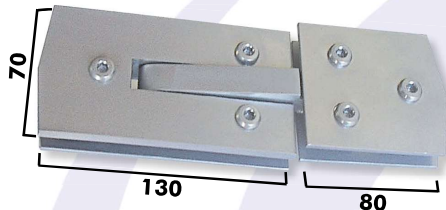
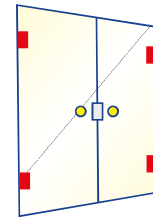

3145

Dobradiça para Porta Vidro/Vidro

Dimensões máximas recomendadas
1000x2100mm

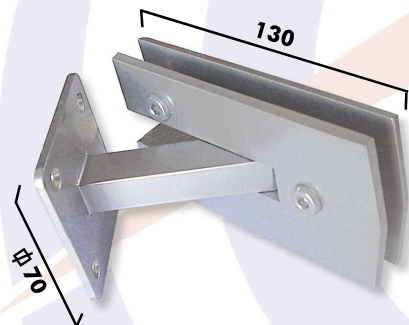
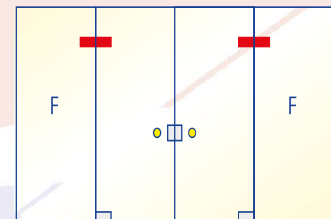

3146

Dobradiça para Porta com Aba Reta

Dimensões máximas recomendadas
1000x2100mm

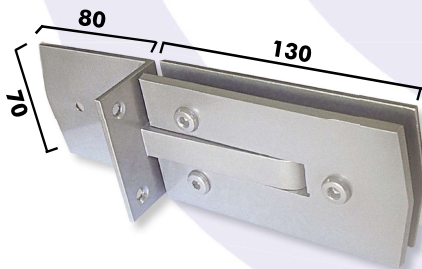
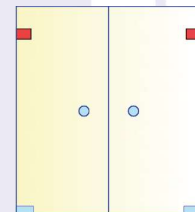

3147

Dobradiça para Porta com Aba a 90°

Dimensões máximas recomendadas
1000x2100mm

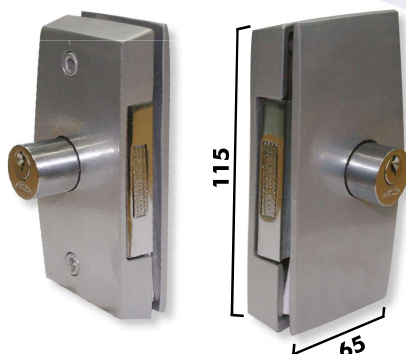
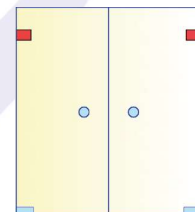

3210

Fechadura de Centro

Disponível em Latão e Zamac
Disponível com Segredo Igual

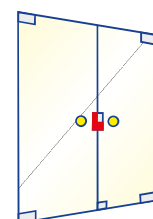

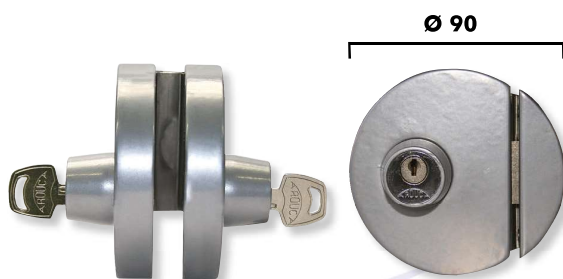

CJ 3210SG

Fechadura e contra VV e VA
pressão com cilindro dos dois lados
(independentes)

Disponível somente em Zamac e nas cores cromada,
preto e branco



3211

Contra Fechadura com Aparador
para 3210

Disponível em Latão e Zamac

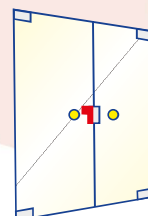

3212

Contra Fechadura sem Aparador
para 3210

Disponível em Latão e Zamac

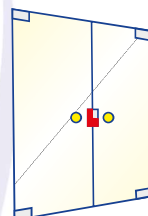

3215

Fechadura de Piso

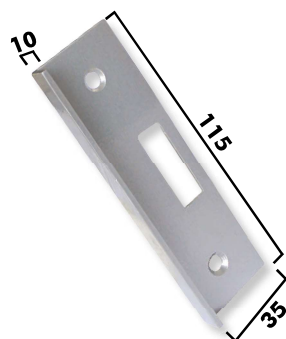
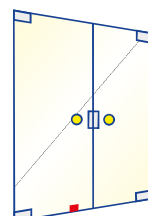

3230 G

Espelho para Fechadura 3210,
3530, 3532 com Aparador

Disponível somente em Zamac

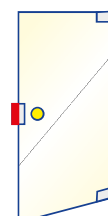

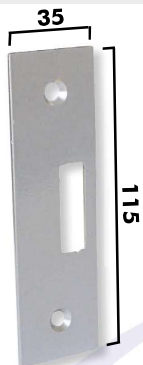

3232 G

Espelho para Fechadura 3210,
3530, 3532 sem Aparador

Disponível somente em Zamac

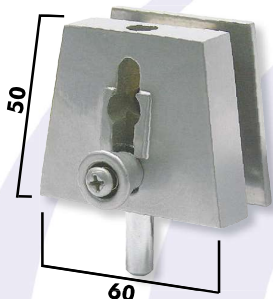
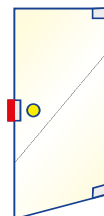

3240

Trinco de Piso

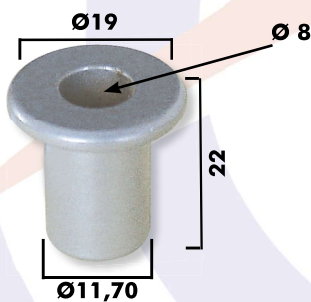
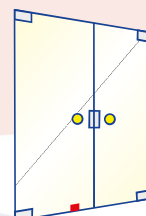

3241

Contra Pino de Piso do Trinco 3240

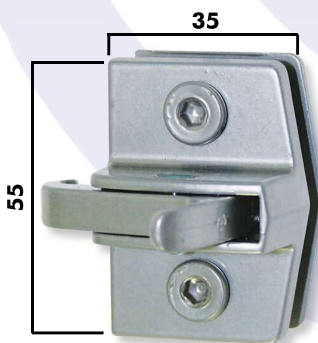
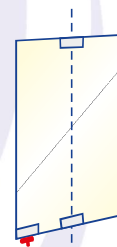

3250 G

Mini Trinco para Janela

Disponível somente em Zamac

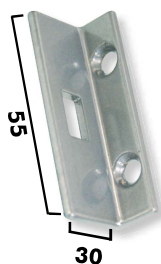
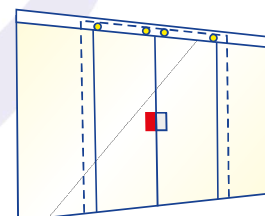

3251 G

Espelho para Mini Trinco
3250 G

Disponível somente em Zamac

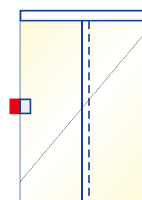

3251 G

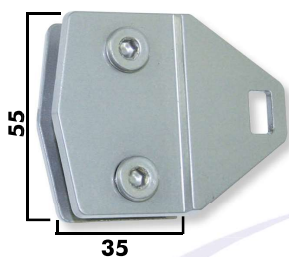

3252 G
Contra VV para Mini Trinco
3250 G
Disponível somente em Zamac

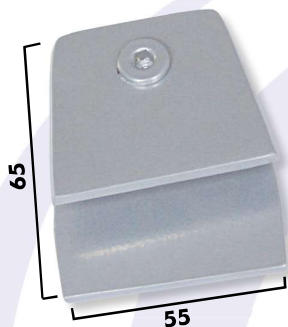
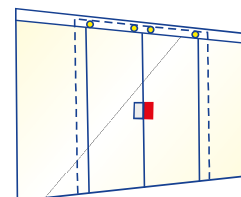

3253
Suporte com Aparador

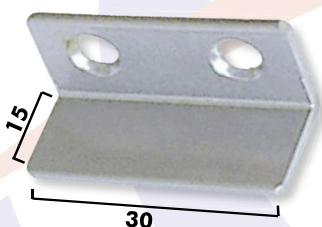
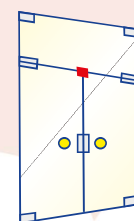

3254
Batedor para Porta de Abrir

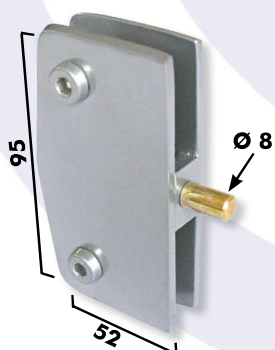
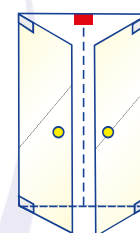

Pino Removível

3401
Dobradiça para Janela
Basculante

Disponível em Latão e Zamac
Dimensões máximas recomendadas
1100x900mm
 $x = \frac{(48.000/A) + B}{2}$

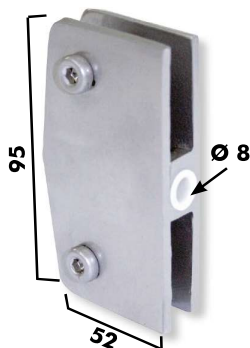
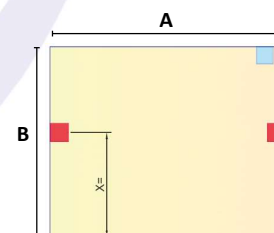

3402
Suporte para Dobradiça de
Janela Basculante

Disponível em Latão e Zamac
Dimensões máximas recomendadas
1100x900mm
 $x = \frac{(48.000/A) + B}{2}$

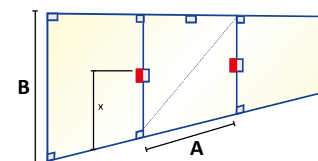

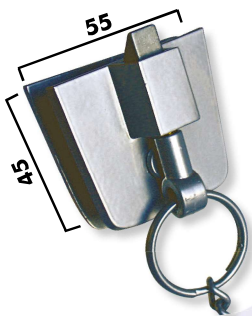

3410

Trinco Superior de Centro para Basculante (Completo)

Disponível em Latão e Zamac

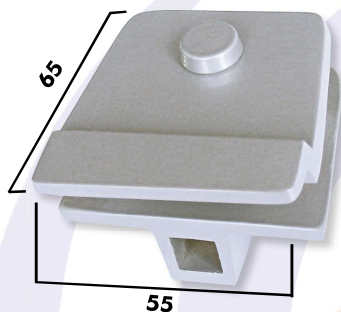
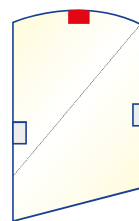

3411

Contra Trinco de Centro para Basculante

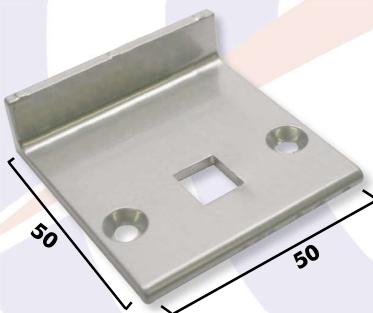
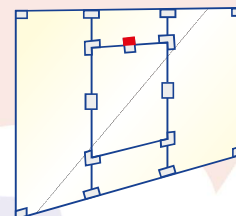

3414 G

Espelho para Trinco de Basculante

Disponível somente em Zamac

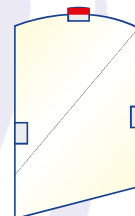

3431 VA

Dobradiça Vidro Alvenaria para Janela 60 mm entre furos

Dimensões máximas recomendadas
800x700mm

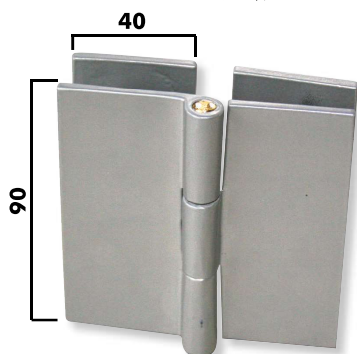

3431 W

Dobradiça Vidro Vidro para Janela 60 mm entre furos

Dimensões máximas recomendadas
800x700mm

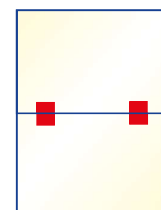

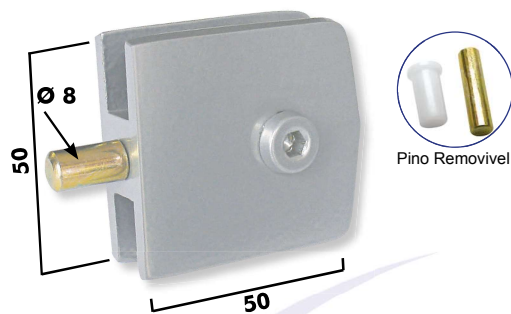

3438 Dobradiça para Janela Basculante (Pequena)

Disponível em Latão e Zamac
 Dimensões máximas recomendadas
 850x750mm
 $X = \frac{(48.000/A) + B}{2}$

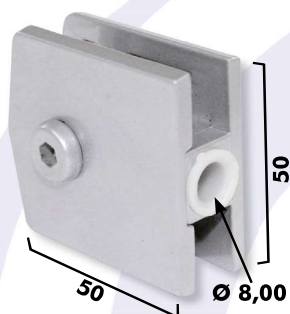
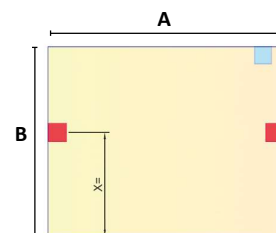

3439 Suporte para Dobradiça de Janela Basculante (Pequena)

Disponível em Latão e Zamac
 Dimensões máximas recomendadas
 850x750mm
 $X = \frac{(48.000/A) + B}{2}$

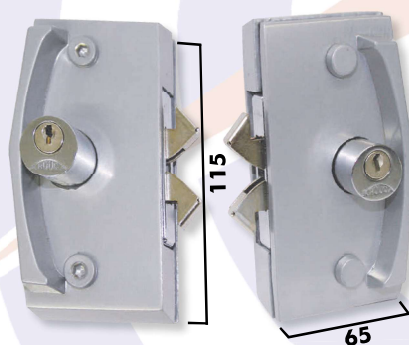
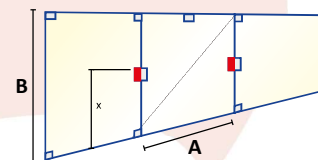

3530 Fechadura para Porta de Correr

Disponível em Latão e Zamac
 Disponível com Segredo Igual

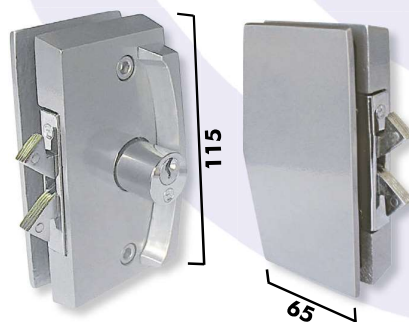
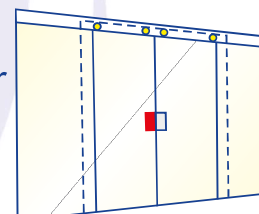

3532 Fechadura para Janela de Correr sem Cilindro Externo

Disponível em Latão e Zamac
 Disponível com segredo igual

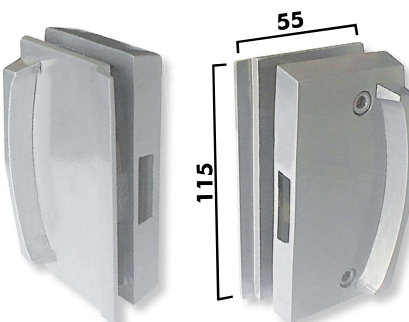
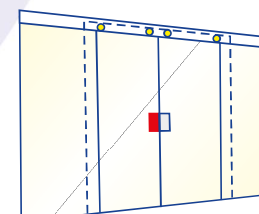

3534 Contra Fechadura para Porta de Correr

Disponível em Latão e Zamac

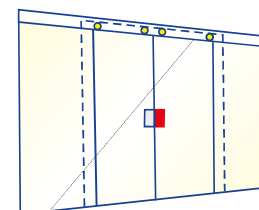

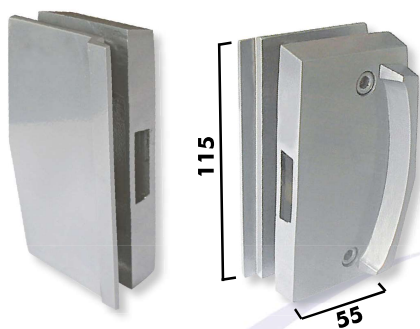

3536

Contra Fechadura para Janela de Correr

Disponível em Latão e Zamac

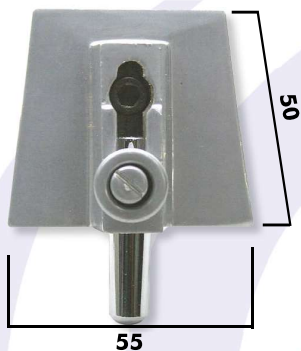
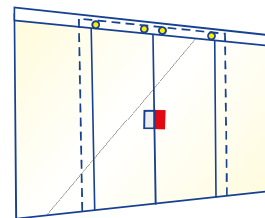

3539

Trinco para Porta de Correr

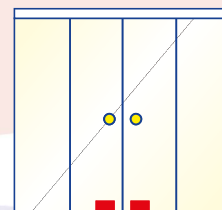

3540

Puxador para Porta de Correr

Disponível em Latão e Zamac

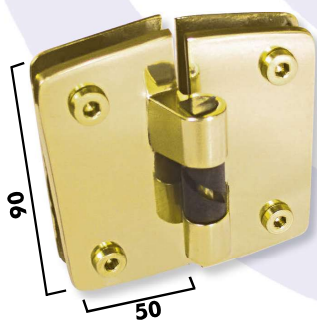
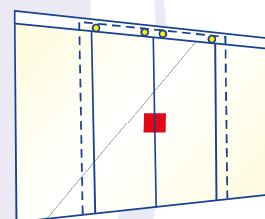

3701

Dobradiça Automática Vidro/Vidro Esquerda

Dimensões máximas recomendadas
600x1900mm - Vidro 8mm

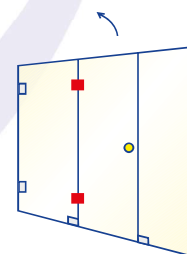

VISTA EXTERNA

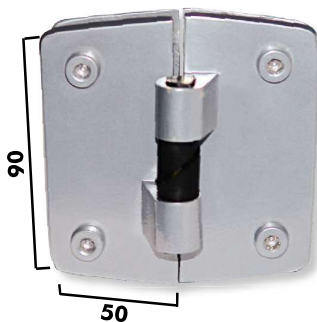

3702

Dobradiça Automática Vidro/Vidro Direita

Dimensões máximas recomendadas
600x1900mm - Vidro 8mm

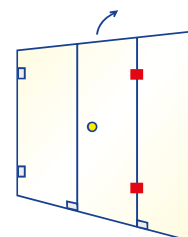

VISTA EXTERNA

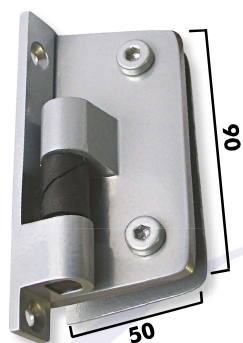

3703 / 3704
Dobradiça Automática
de Batente Direita e Esquerda
Dimensões máximas recomendadas
600x1900mm - Vidro 8mm

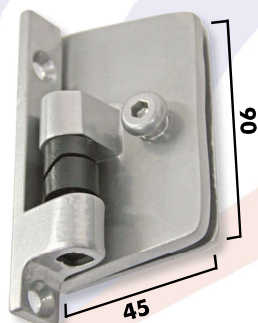
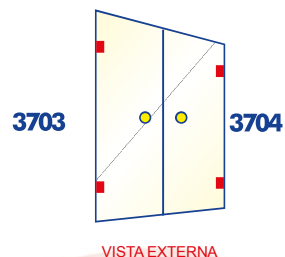

3713 / 3714
Dobradiça Automática
de Batente Direita e Esquerda
Pequena com 1 Furo
Dimensões máximas recomendadas
500x1900mm - Vidro 8mm

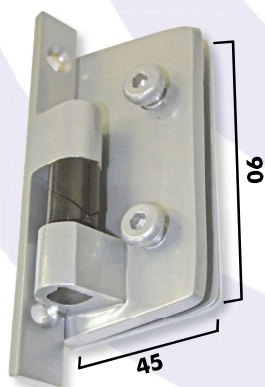

3715
Dobradiça Automática
de Batente Esquerda

3716
Dobradiça Automática
de Batente Direita
Dimensões máximas recomendadas
600x1900mm - Vidro 8mm

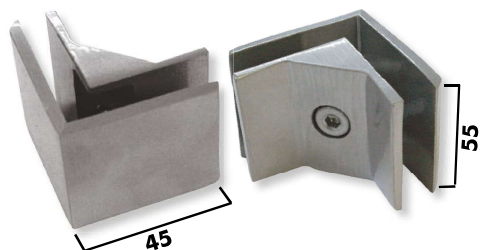
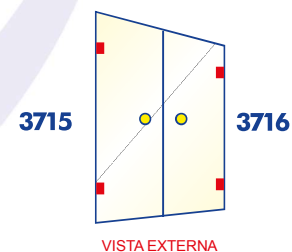

3730
Cantoneira de Centro
para Box
Vidro 8mm

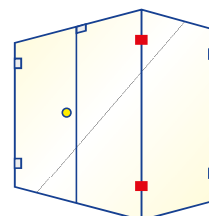

DM VA G - Dobradiça Maxmar
Vidro Alvenaria Zamac (40mm entre furos)
Dimensões máximas recomendadas
800x700mm

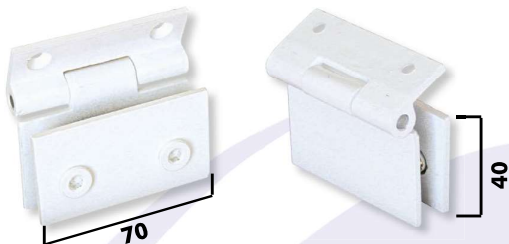

VISTA INTERNA

VISTA EXTERNA

DM VV G - Dobradiça Maxmar
Vidro Vidro Zamac (40mm entre furos)
Dimensões máximas recomendadas
800x700mm

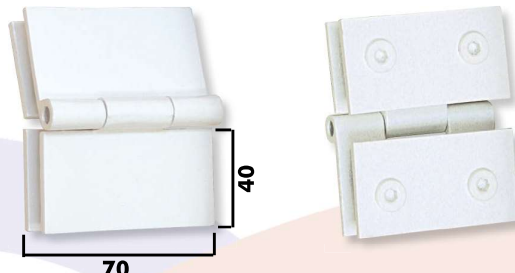

VISTA EXTERNA

VISTA INTERNA

HT
Haste Tubular para Maxmar

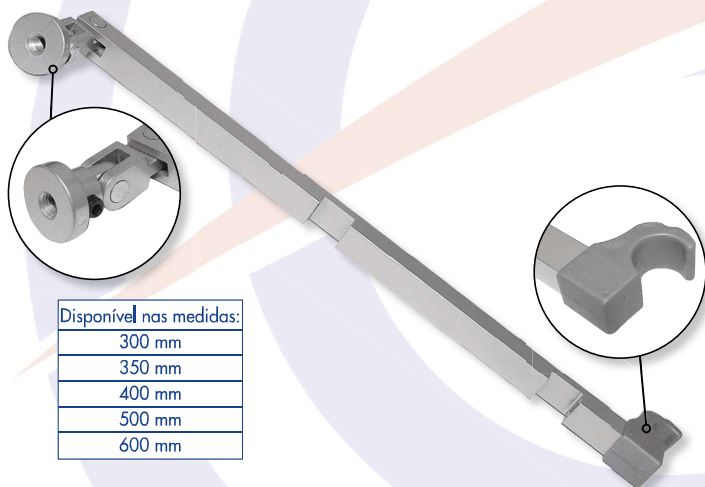

Disponível nas medidas:
300 mm
350 mm
400 mm
500 mm
600 mm

AHV2F
Suporte Haste VV com 2 Furos

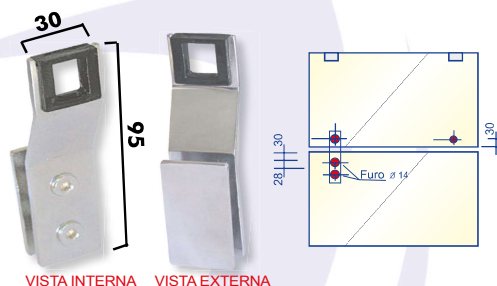

VISTA INTERNA

VISTA EXTERNA

CHVA
Cadeirinha Haste VA



CHVV
Cadeirinha Haste VV



SHVA
Suporte Haste VA



SHVV
Suporte Haste VV





Aplicação

PC 3000

Porta Cadeado para Fechaduras e Contras VV Linha 3000 (3210, 3530 e 3532)

PAT 005299-8

Cadeado, fechadura e contra fechadura não acompanham o porta cadeado

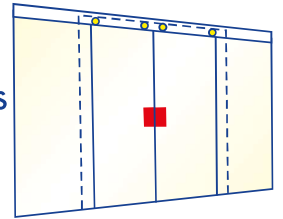

Aplicação

PTC 510

Porta Cadeado para Fechadura 1510 e Contra VV 1511

PAT 005300-5

Cadeado, fechadura e contra fechadura não acompanham o porta cadeado

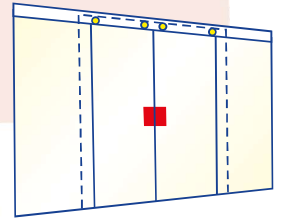

Aplicação

PTC 520

Porta Cadeado para Fechadura 1520 e Contras 1531 ou 1504

PAT 005300-5

Cadeado, fechadura e contra fechadura não acompanham o porta cadeado

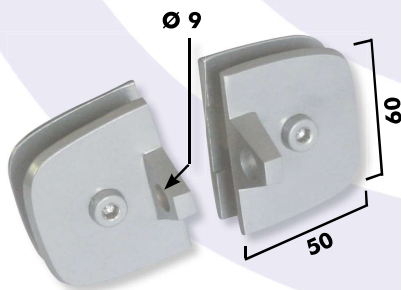
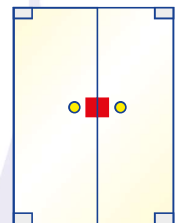

PC

Porta Cadeado VV

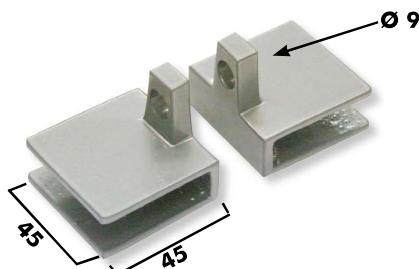
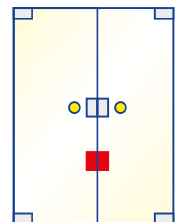

PCS

Porta Cadeado VV Pressão

Vidros de 8mm e 10mm

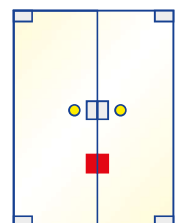

*Ferragens não acompanham cadeado

Pinça MD G

Pinça para Guarda Corpo Pressão Média

Vidros de 8mm e 10mm
Dimensões máximas recomendadas
800x600mm

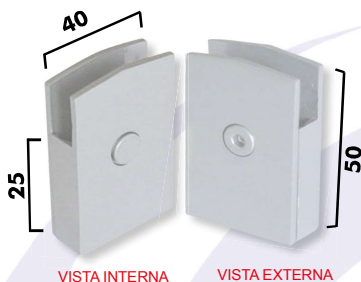

VISTA INTERNA

VISTA EXTERNA

Pinça GRD G

Pinça para Guarda Corpo Pressão Grande

Vidros de 8mm e 10mm
Dimensões máximas recomendadas
1000x800mm



VISTA INTERNA

VISTA EXTERNA

SGC M

Suporte para Guarda Corpo Pressão Médio
Medida A: 20 mm

Vidros de 8mm e 10mm
Dimensões máximas recomendadas
800x600mm



VISTA INTERNA

VISTA EXTERNA

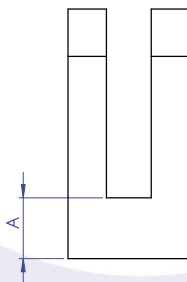

SGC G

Suporte para Guarda Corpo Pressão Grande
Medida A: 30 mm

Vidros de 8mm e 10mm
Dimensões máximas recomendadas
1000x800mm

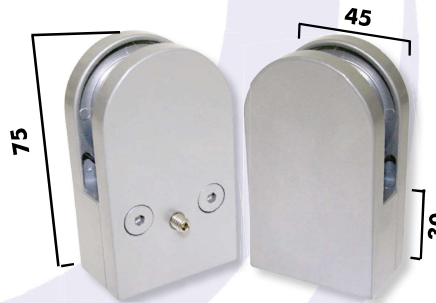

VISTA INTERNA

VISTA EXTERNA

SGC M38

Suporte para Guarda Corpo Pressão Médio com Base Raiada para Tubo 38mm

Vidros de 8mm e 10mm
Dimensões máximas recomendadas
800x600mm

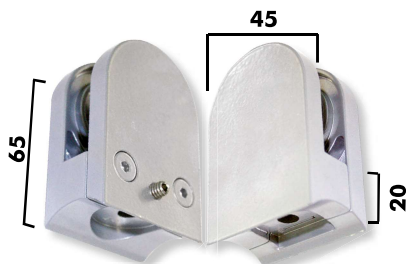

VISTA INTERNA

VISTA EXTERNA

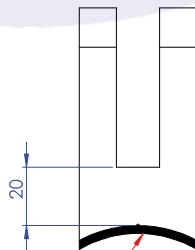

Raios para tubo
Ø38 ou Ø50

SGC M50

Suporte para Guarda Corpo Pressão Médio com Base Raiada para tubo 50mm

Vidros de 8mm e 10mm
Dimensões máximas recomendadas
1000x800mm

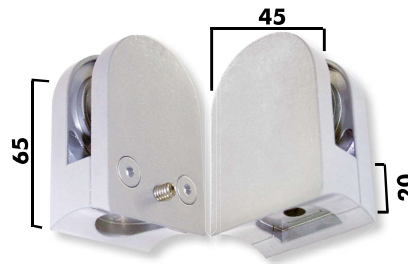

VISTA INTERNA

VISTA EXTERNA

*Produtos disponíveis somente em Zamac.
Medidas em milímetros / Todas as cotas são apenas referência

1122 AM

Carrinho Mini para Janela de Correr
Roldana Meia Cana

Dimensões máximas recomendadas
500x1700mm - Vidro 8mm
Disponível somente em Alumínio

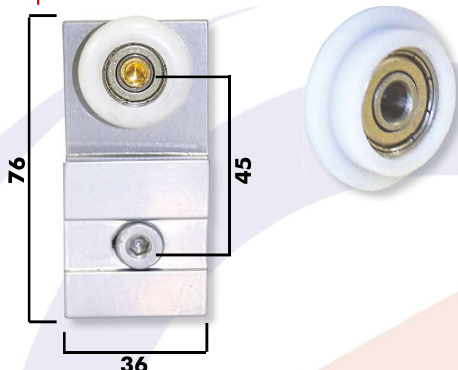

1122 AMC

Carrinho Mini para Janela de Correr
Roldana Côncava

Dimensões máximas recomendadas
600x1900mm
Disponível somente em Alumínio

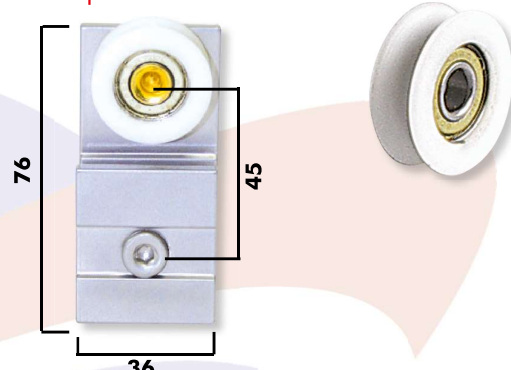

1122 A

Carrinho Duplo para Porta de Correr
Roldanas Meia Cana (40mm entre furos)

Dimensões máximas recomendadas
800x1800mm - Vidro 8mm
Disponível somente em Alumínio

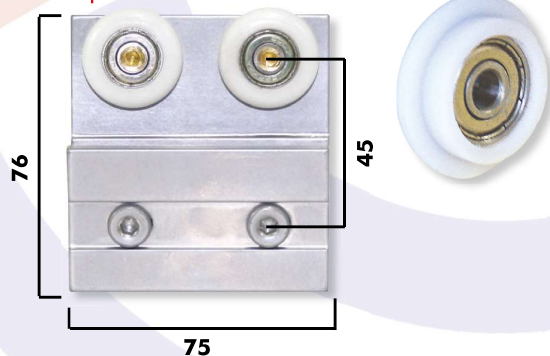

1122 AC

Carrinho Duplo para Porta de Correr
Roldanas Côncava (40mm entre furos)

Dimensões máximas recomendadas
700x2100mm
Disponível somente em Alumínio

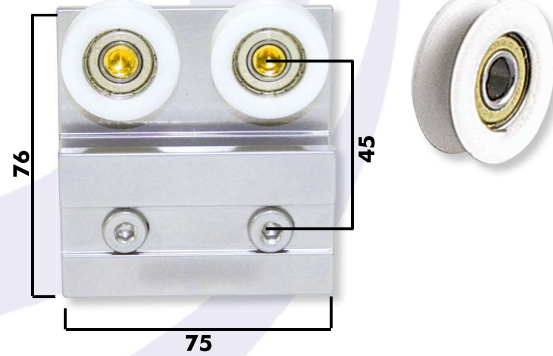

1 PXUG

Puxador para Portas de Correr
Disponíveis com Diâmetro de 40mm

Furo \varnothing 10 mm
Disponível somente em Zamac



APXL

Puxador em L
Furo \varnothing 10 mm

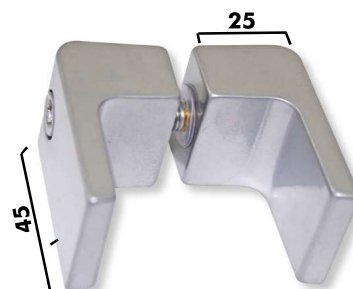

TORRE

Torre Tubular para Guarda Corpo em Aço Inoxidável com alma interna para ser chumbada em concreto.

Vidros:
16 a 20mm;

Peso Suportado:
25 Kg por Peça
1200x1000 (16mm)
1000x1000 (20mm)

Furos do vidro: 20 mm

Medida A
1º Posição = 100
2º Posição = 200

APLICAÇÃO:

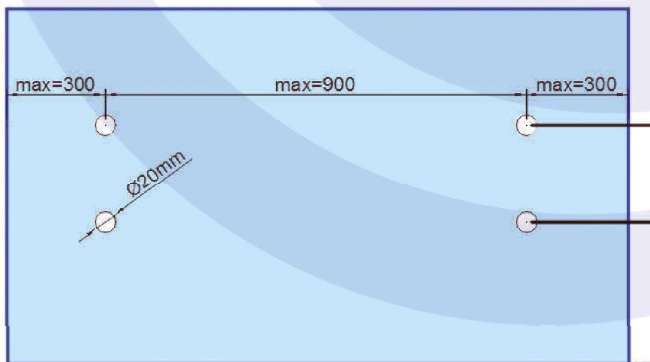

Conforme Norma NBR 14718 e 7199 os vidros para Guarda Corpo devem ser laminados e ou laminados de temperado. Neste caso devem-se utilizar vidros laminados temperados, por obter furos nos vidros.

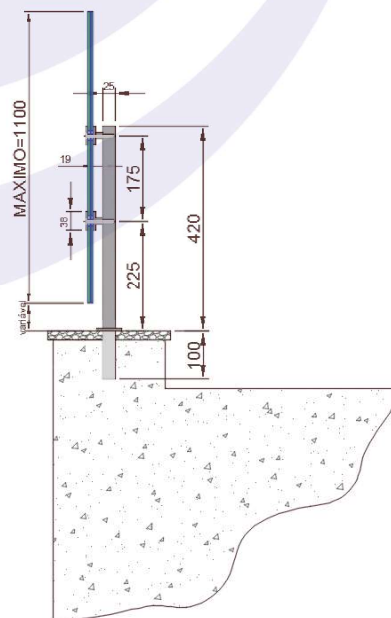
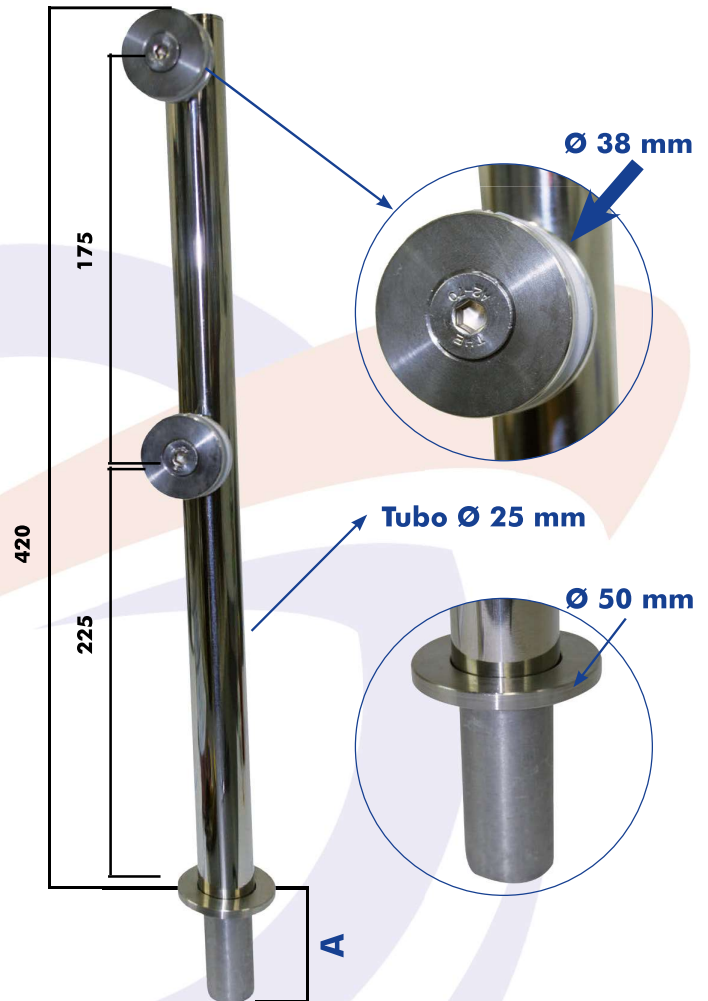

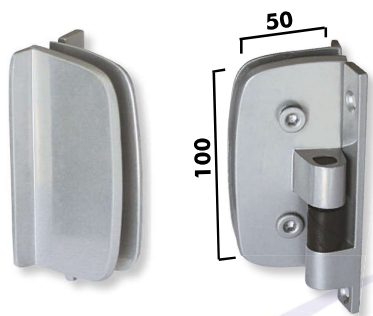

1114A

Dobradiça Automática para Box com aba na tampa.

Dimensões máximas recomendadas
600x1900mm - Vidro 8mm

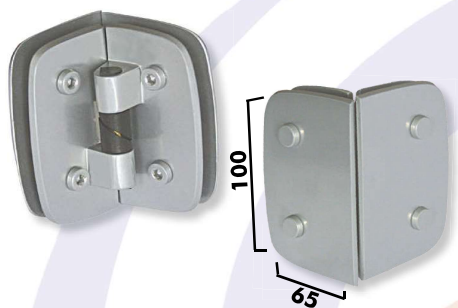
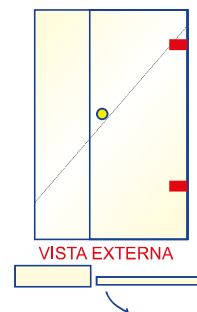

1129D à 90°

Dobradiça Dupla Automática Vidro Vidro Direita - Só abre pra dentro

Dimensões máximas recomendadas
600x1900mm - Vidro 8mm

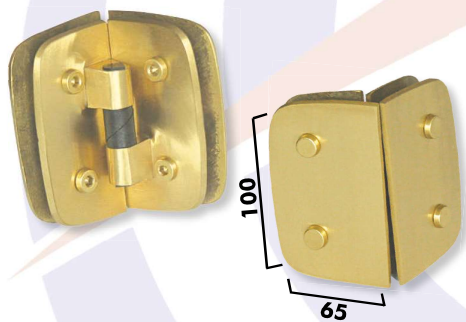
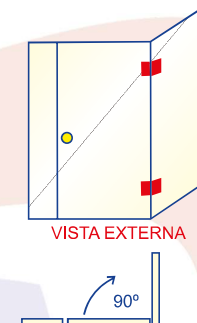

1129E à 90°

Dobradiça Dupla Automática Vidro Vidro Esquerda - Só abre pra dentro

Dimensões máximas recomendadas
600x1900mm - Vidro 8mm

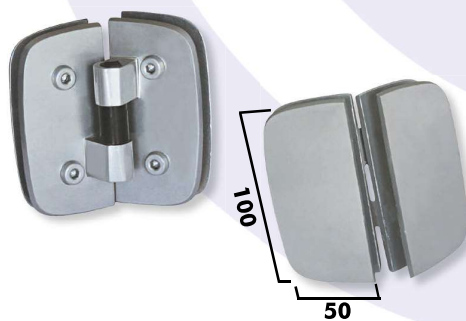

1129D à 135°

Dobradiça Dupla Automática Vidro Vidro Direita - Só abre para dentro

Dimensões máximas recomendadas
600x1900mm - Vidro 8mm

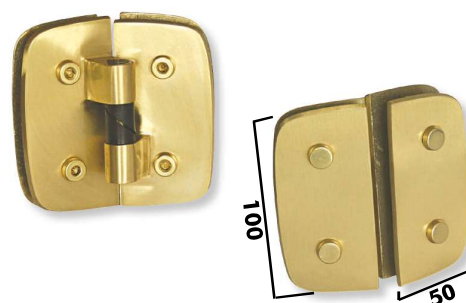
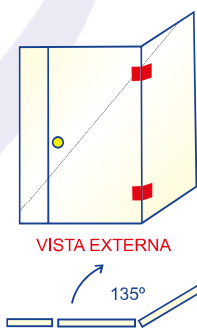

1129E à 135°

Dobradiça Dupla Automática Vidro Vidro Esquerda - Só abre para dentro

Dimensões máximas recomendadas
600x1900mm - Vidro 8mm

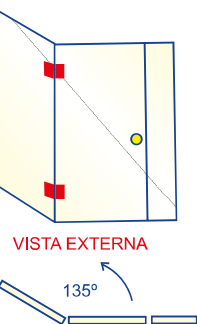

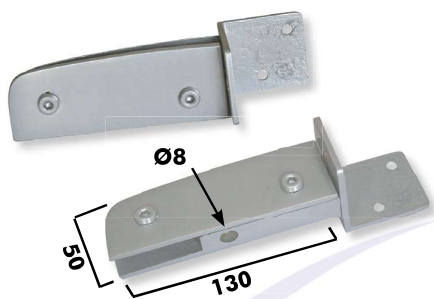

1203 - Tubo 50x50 Suporte com Bandeira Fixo em Tubo Quadrado

Para correta fabricação e instalação, pedido deverá acompanhar desenho de planta baixa

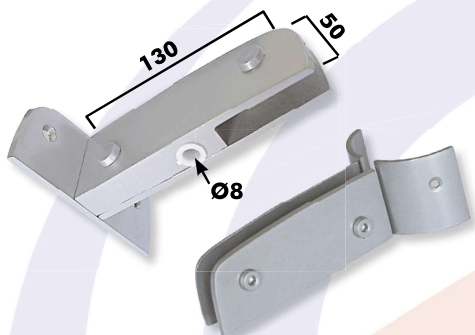
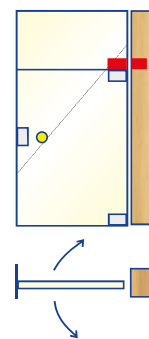

1203 - Tubo Ø50 ou Ø75 Suporte com Bandeira Fixo em Tubo Redondo

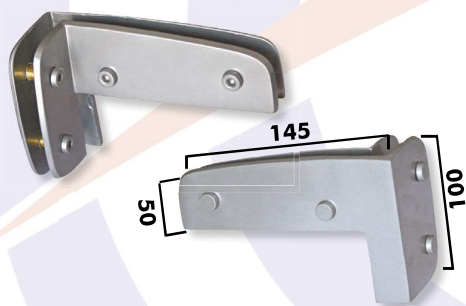
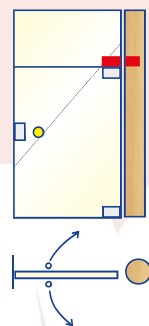

1209 D à 90° Facão Direito p/ Lateral e Bandeira

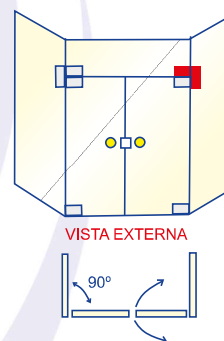

1209 E à 90° Facão Esquerdo p/ Lateral e Bandeira

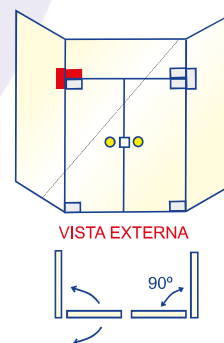

1209 D à 135° Facão Direito p/ Lateral e Bandeira

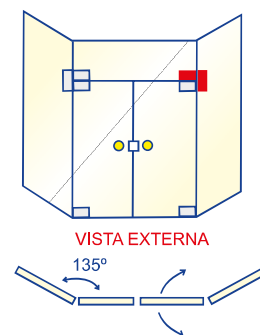

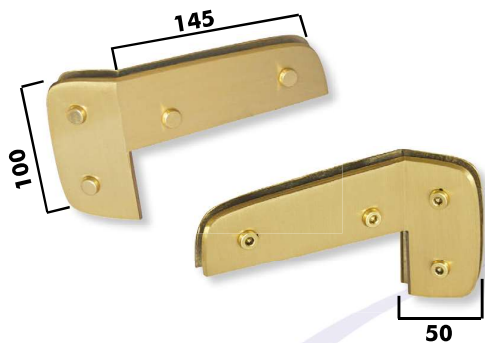

1209 E à 135°
Facção Esquerdo p/ Lateral
e Bandeira

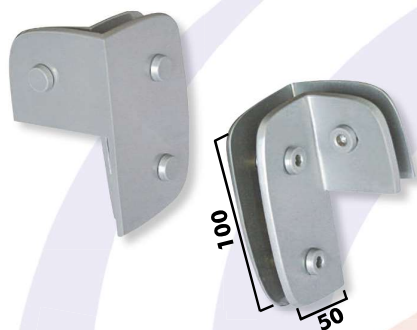
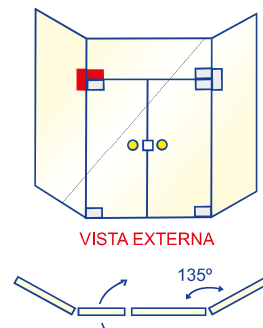

1310 D à 90°
Suporte Direito para União
de Dois ou mais Vidros em "L"

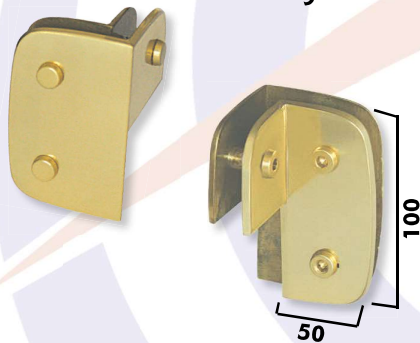
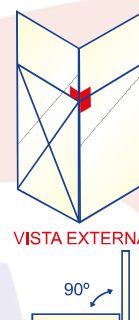

1310 E à 90°
Suporte Esquerdo para União
de Dois ou mais Vidros em "L"

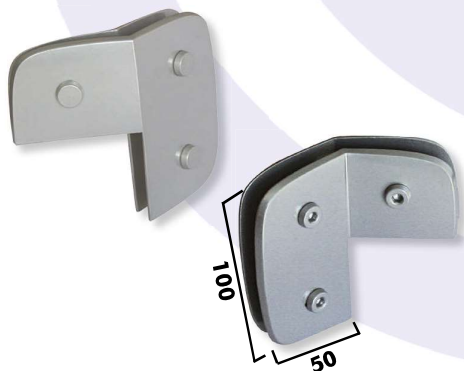
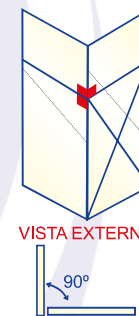

1310 D à 135°
Suporte Direito para União
de Dois ou mais Vidros em "L"

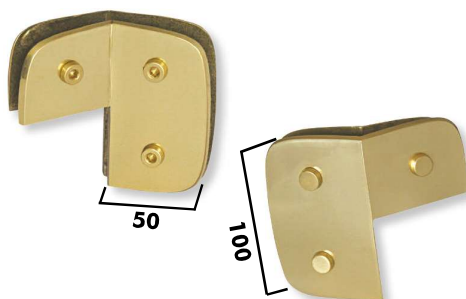
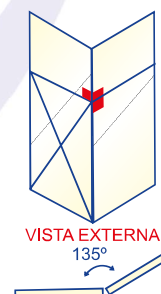

1310 E à 135°
Suporte Esquerdo para União
de Dois ou mais Vidros em "L"

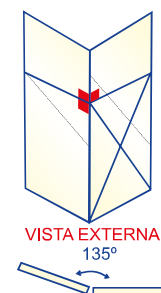

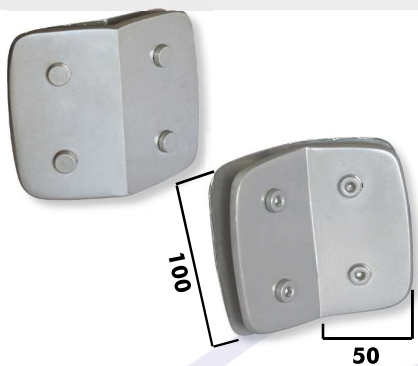

1319 à 135°
Suporte para União de Quatro Vidros

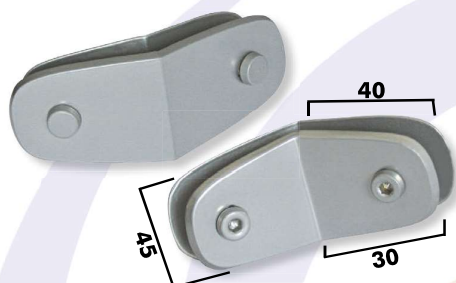
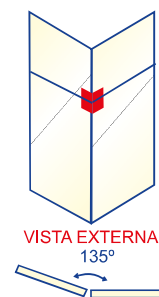

1320 à 135°
Suporte sem Miolo para União de Dois Vidros

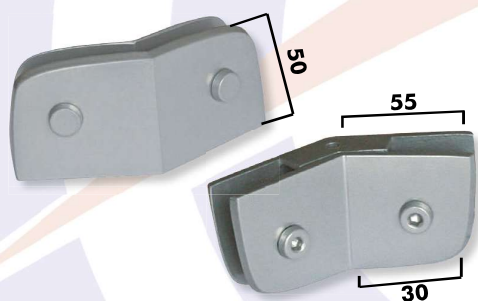
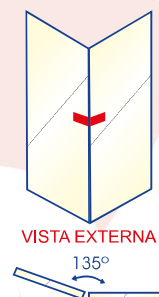

1321 à 135°
Suporte com Miolo para União de Dois Vidros

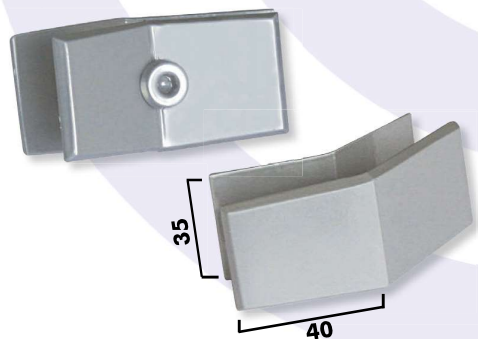
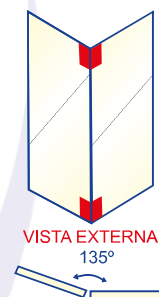

1322 à 135°
Suporte para União de Dois Vidros

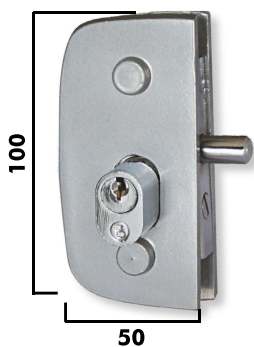
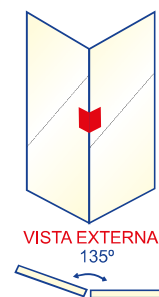

1520 Pino Longo
Fechadura Central com Pino Alongado
Disponível com: 25/35/45 mm
Disponível em Latão e Zamac

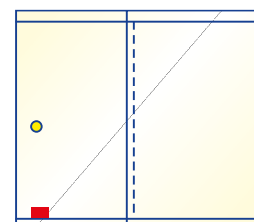

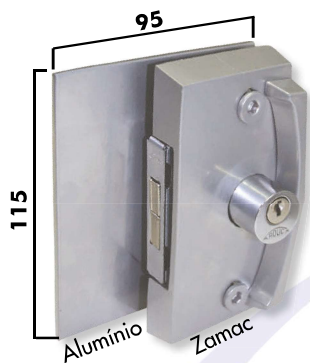

3530 / 3532 à 90°G
 Fechadura para porta
 ou Janela de Correr
 Com Fechamento a 90°
 Recorte Especial ao final do catálogo
 Disponível somente em Alumínio e Zamac

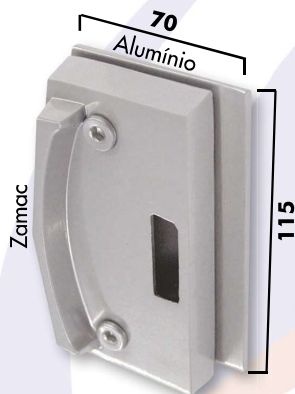
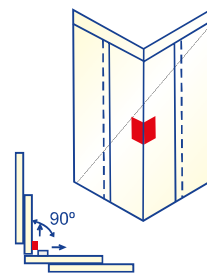

3534 / 3536 à 90°G
 Contra Fechadura para porta
 ou Janela de Correr
 Com Fechamento a 90°
 Recorte Convencional 3534 / 3536
 Disponível somente em Alumínio e Zamac

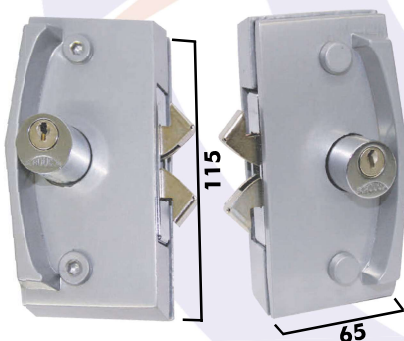
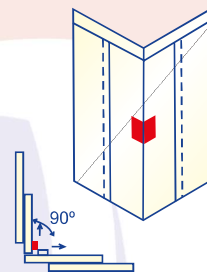

3530 / 3532 à 135°
 Fechadura para Porta
 ou Janela de Correr
 Com Fechamento a 135°
 Recorte Convencional 3530 / 3532
 Disponível somente em Latão

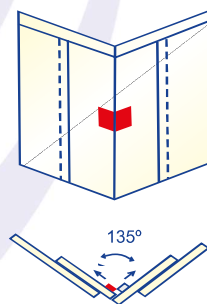

3534 / 3536 à 135°
 Contra Fechadura para Porta
 ou Janela de Correr
 Com Fechamento a 135°
 Recorte Convencional 3534 / 3536
 Disponível somente em Latão

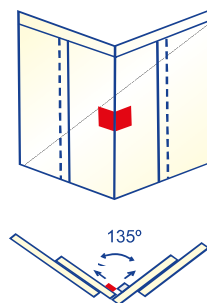

DOBRADIÇA 1129 VIDRO / GRANITO

Para a produção dessas dobradiças são necessárias as seguintes informações:

Dimensões máximas recomendadas 600x1900mm - Vidro 8mm

1. Lado da dobradiça, que poderá ser:

A) 1129 D
(Vista Externa)

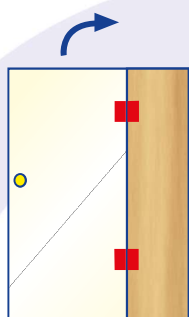

VISTA EXTERNA

A) 1129 E
(Vista Externa)

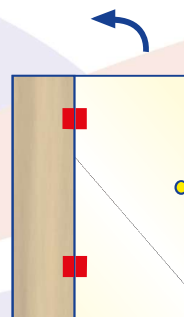

VISTA EXTERNA

2. Espessura da Pedra de Granito:

3. Posição do Vidro na Pedra, que poderá ser

3.1 No centro da Pedra de Granito, conforme ilustração



3.2 Rente a Pedra pelo lado interno, conforme ilustração



3.3 Rente a Pedra pelo lado externo, conforme ilustração



Prolongador PL 1



Prolongador PL 2

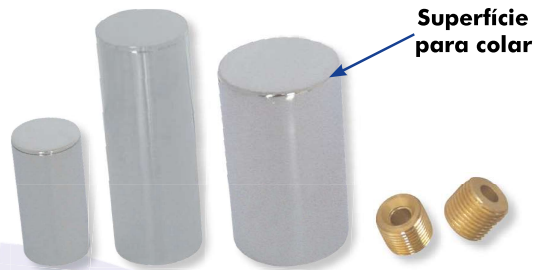

Prolongador PL 3



Prolongador PL 4



Prolongador PL 5



PL 6 Canopla 1



PL 7 - Roldana para Cola UV



PL 8 - Canopla 2



PL 9 - Roldana com Tubo



TB - Tampa Tubo



PL R - Prolongador Reforçado

(Diâmetro e altura sob encomenda, de acordo com projeto) - Furação do vidro: \varnothing 16 mm a \varnothing 18 mm

*Recomendado apenas para instalações em concreto, não recomendado para alvenaria simples.
Dimensões máximas recomendadas: 2000x1300mm, utilizando 6 prolongadores em cada vidro.

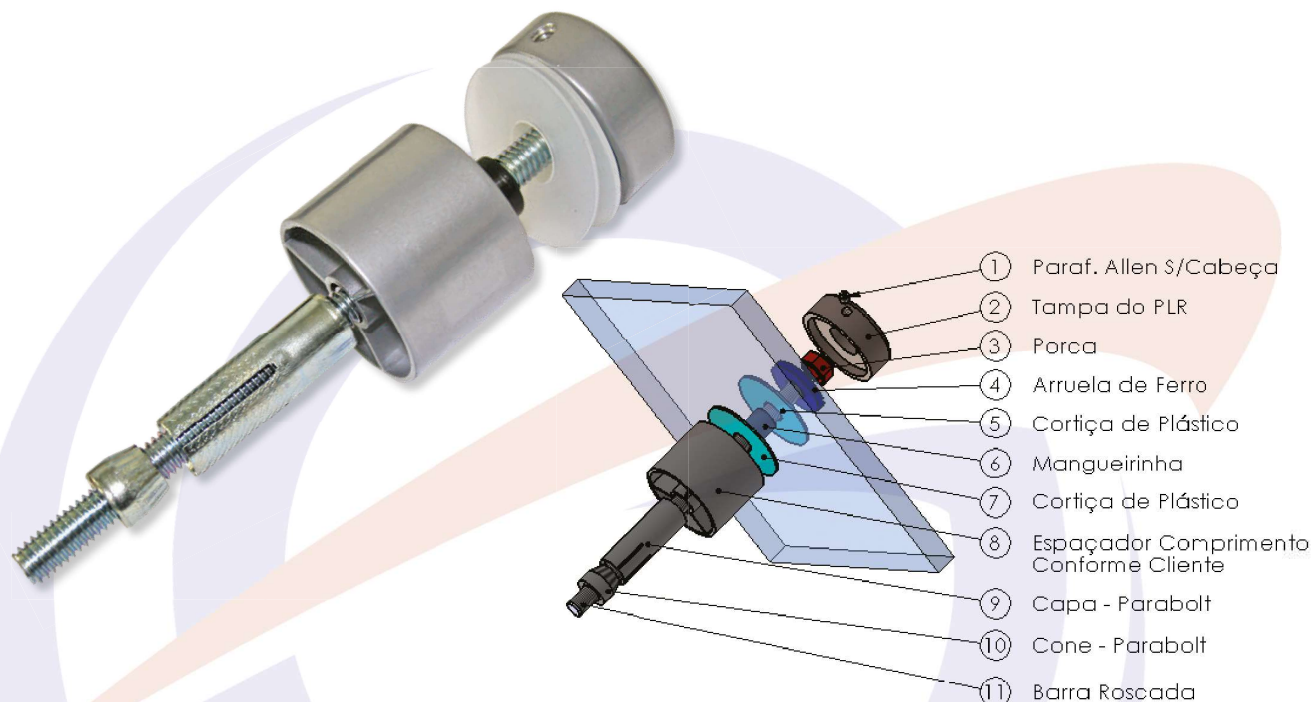

APLICAÇÃO:

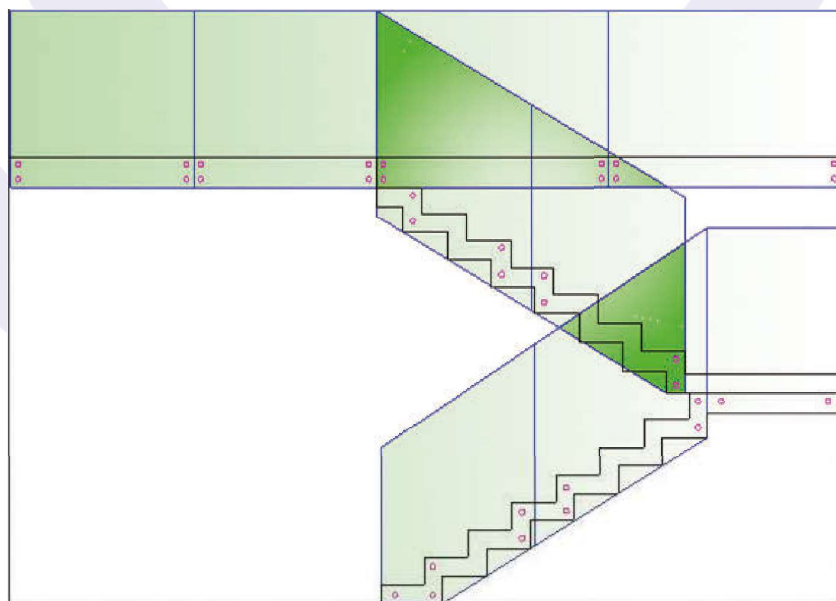

Suporta 12 kg por prolongador. Para aplicação correta entrar em contato com depto. técnico. Conforme a norma NBR 14718 e NBR 7199 os vidros devem ser Laminados e temperados

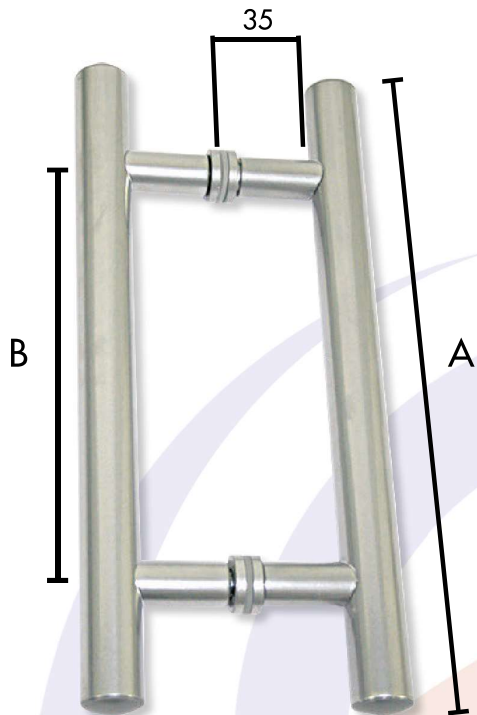

Puxador Tubular H
Tubo Diâmetro 25 ou 38 mm
Disponível somente em Alumínio

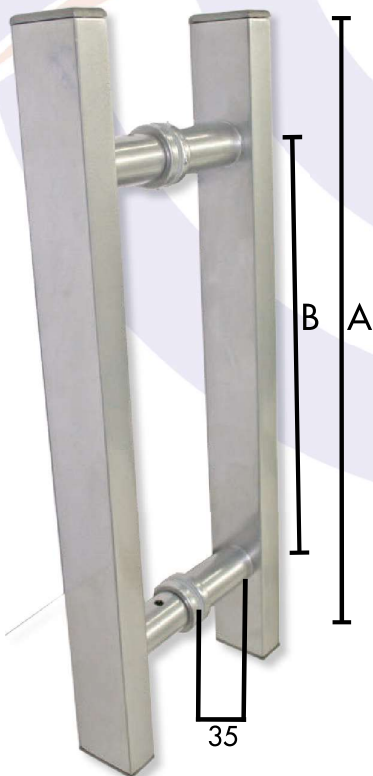

Puxador Tubular Retangular
Disponível somente em Alumínio

Dimensões:
para Puxadores Tubulares
H Redondo, Retangular.

A	B
COMPRIMENTO TOTAL	DISTÂNCIA ENTRE O FURO
300	200
400	300
500	300
600	400
800	600
1000	800

Os Puxadores em Alumínio não são disponíveis na cor dourada.
Furo Ø 12 mm

Puxador Tubular 276

200 mm entre furos

Disponível somente em Alumínio



Puxador Tubular 376

300 mm entre furo

Disponível somente em Alumínio



Puxador Tubular 25 MW

Disponível somente em Alumínio



**Ideal
para portas
de correr**

DIMENSÕES

200 mm
300 mm
400 mm
500 mm
600 mm

Puxador Tubular H

Com tarugo central passante e 2 tarugos colantes

Disponível somente em Alumínio

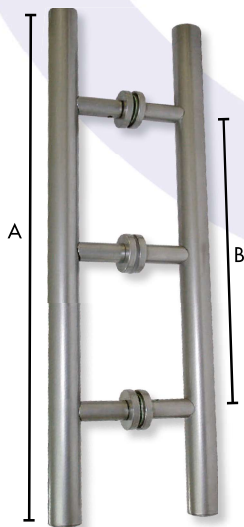

Puxador Tubular H de um lado só

Tubo Diâmetro 25 ou 38 mm

Disponível somente em Alumínio

Disponível no formato retangular.

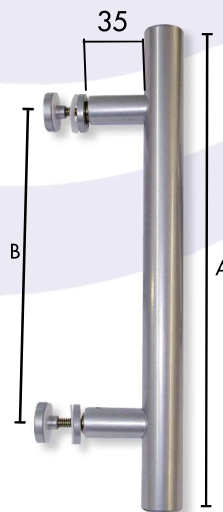

Dimensões:
para Puxadores Tubulares
H1F e de um lado só

A	B
COMPRIMENTO TOTAL	DISTÂNCIA ENTRE O FURO
300	200
400	300
500	300
600	400
800	600
1000	800

Os Puxadores em Alumínio não são disponíveis na cor dourada.
Furo Ø 12 mm

B 201

Bucha para
1201/1203/1209



N 114

Nylon para 114/129/
2708/3704/3701/3702/
3715 / 3716
Base Redonda



114 QUAD

Nylon para 114/129 -
Base Quadrada



N 115

Nylon para 115/129



PN

Pino Dobradiça
114/129/2708



Capa para Parafuso

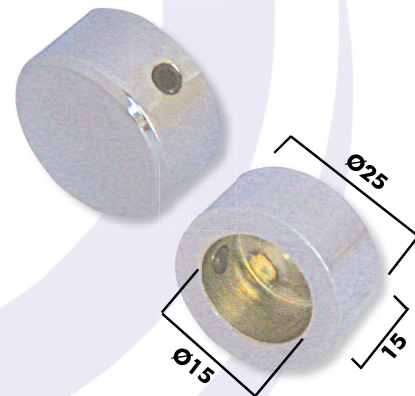

Chave Alen Sextavada



Suporte Fecho Magnético

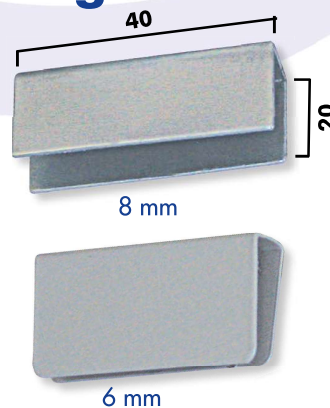

Fecho Magnético



FC

Folha Cortiça 600x450



GB

Guia para Box



M 2000 - Miolo para Dob. linha 2000

M 3000 - Miolo para Dob. linha 3000

M 103 - Miolo para 103



1 P 126

Parafuso e Bucha 1 126



1 PA

Parafuso e Bucha Alen



1 PA 3000

Parafuso e bucha Linha 3000



TR 335 Longo

Pino e Trava 1335 Longo

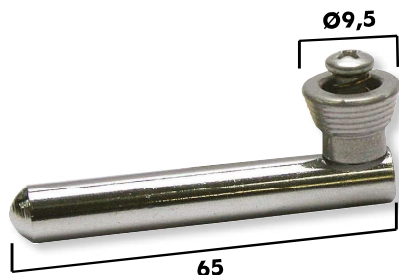

TR 335

Pino e Trava 1335

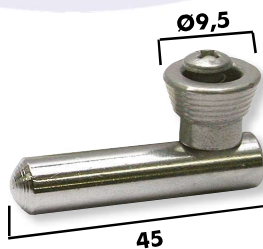

P 101

Pino Dob. 101 e 123

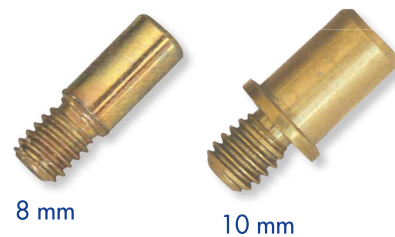

Carrinho 1126KDKE Com Sistema de Mão Amiga

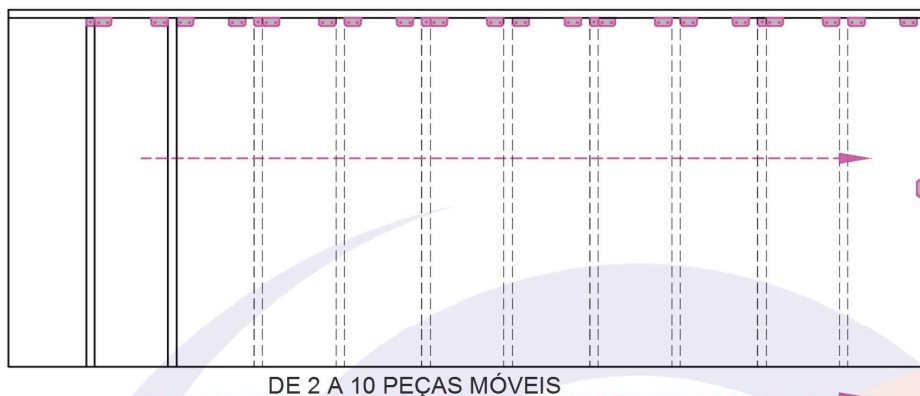

O Sistema de carrinho KD/KE pode ser utilizado a partir de 2 peças móveis até 10 peças móveis, sem a necessidade de trinco 1800F ou Mão amiga.

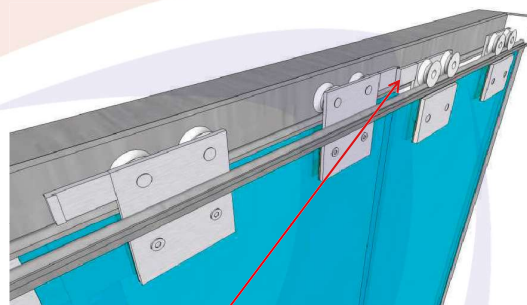

A mão amiga fica internamente dentro do trilho Stanley já no carrinho.

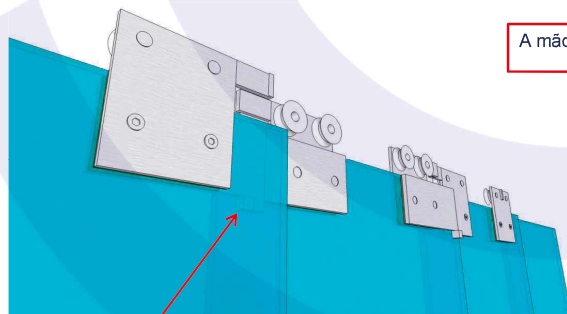

Para o sistema funcionar na troca de um trilho para outro, na tampa do carrinho, tem um pegador que faz a função de puxar e empurrar os vidros do sistema.



Para produção do Kit KDKE é necessário algumas informações importantes:

- 1.1 - KD - Carrinho Direito (O fixo determina o lado do carrinho considerando Vista externa.
- 1.2 - KE - Carrinho Esquerdo (O fixo determina o lado do carrinho considerando Vista externa.
- 1.3 - Informar a qtde de peças que irão correr (Na figura acima é um KD 3 móveis e 1 fixo).

No kit irá o conjunto com as peças necessárias para 3 peças móveis funcionar.
Não está incluso no kit a fechadura e o suporte de canto (1302) do fixo.

Carrinho 1126KDKE Com Sistema de Mão Amiga

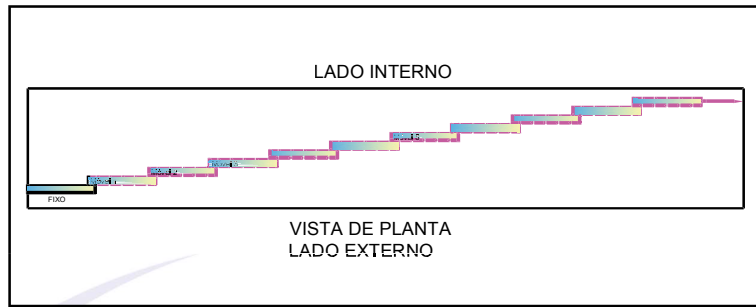

- 2.1 - Passar desenho em vista de planta, demonstrando a posição do vidro fixo, identificando o lado e a posição (interno/Externo) em que o vidro fixo irá ficar.
- 2.2 - Informar no desenho a vista interna e externa. (conforme figura acima).
- 2.3 - O transpasse é de 50mm para cada folha.
- 2.4 - O código para recorte do carrinho é o padrão 1126DC

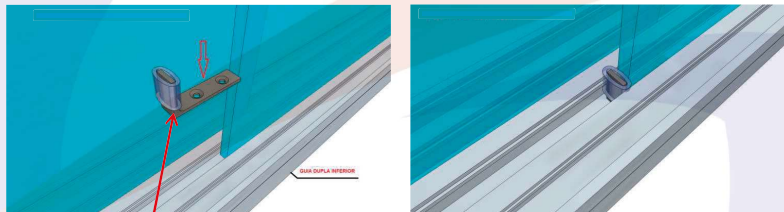

Limitador para última porta, eliminando a necessidade do trinco 1800F.
INCLUSO NO KIT.

Para sistema de carrinho KD/KE sem fixo deve se levar em conta a seguinte situação.



VISTA DE PLANTA
LADO EXTERNO

Neste exemplo temos um KE com 4 móveis, portanto é necessário informar a posição da porta que irá ficar na posição externa, determinando assim o lado do carrinho.

LADO INTERNO

1 Conferir as medidas do vão

2100,0mm
1450,0mm

2 Fixar o Trilho Stanley Externo com parafuso a cada 500mm.

3 Fixar o Trilho Stanley Interno com parafuso a cada 500mm.

4 Com o Prumo de centro, transferir o ponto de fixação da guia inferior externa e interna.

PRUMO DE CENTRO
PRUMO DE CENTRO

5 Fixar as guias inferiores.

GUIA DUPLA INFERIOR







6 Efetuar a medição do perfil "U" do fixo. Medir entre a face inferior do trilho stanley e a face superior da guia dupla externa.

2027
2027

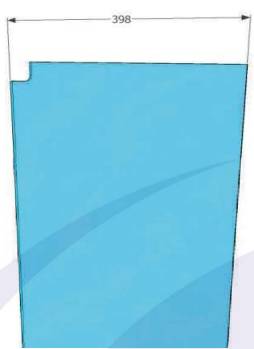
7 Fixar o Perfil "U" conforme ilustração.

8 Alinhar o eixo do Perfil "U" com o eixo do friso do trilho externo.

TRILHO STANLEY
PERFIL "U" FIXO

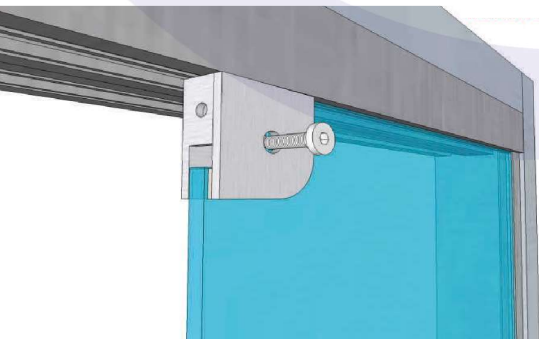
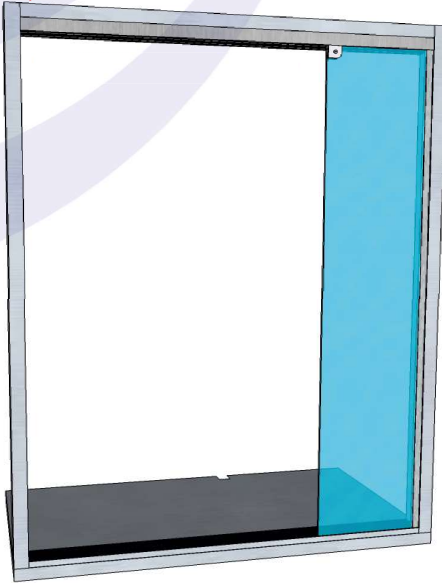
<p>9 Medir a largura do vidro fixo para marcar a posição do suporte de canto - 1302</p> 	<p>10 Medida do fixo + 4mm marcar no trilho a posição do</p> 
<p>11 Colocar o suporte de canto na marcação e fazer o furo do suporte 1302</p> 	<p>12 Fixar a 1302</p> 
<p>13 Colocar uma cunha de nylon dentro da canaleta onde será colocado o vidro fixo</p> 	<p>14 Encaixar o vidro fixo na posição.</p> 
<p>15 Prender o vidro com a ferragem 1302</p> 	<p>16 Aprumar o vidro fixo.</p> 

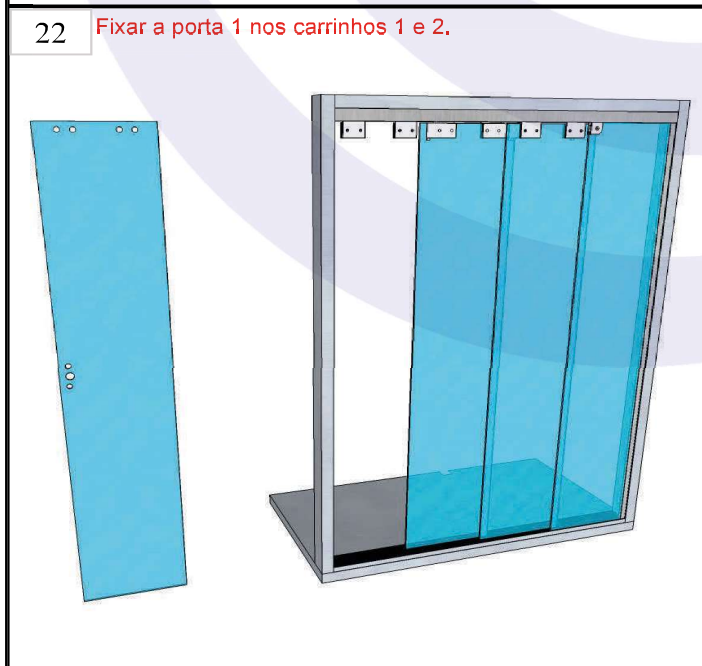
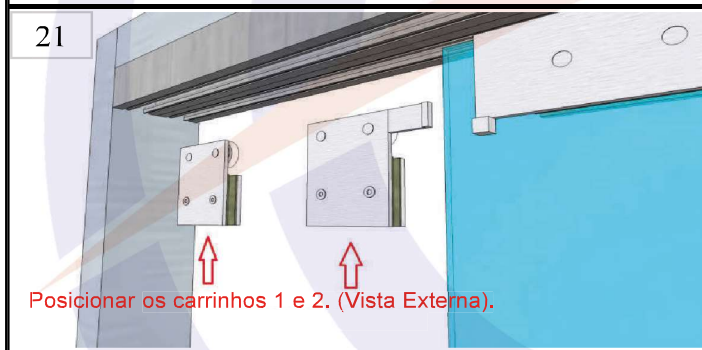
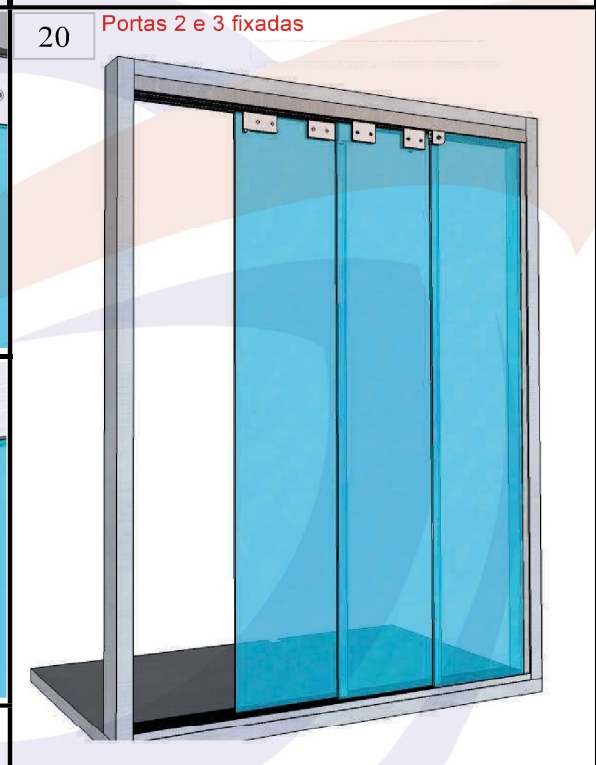
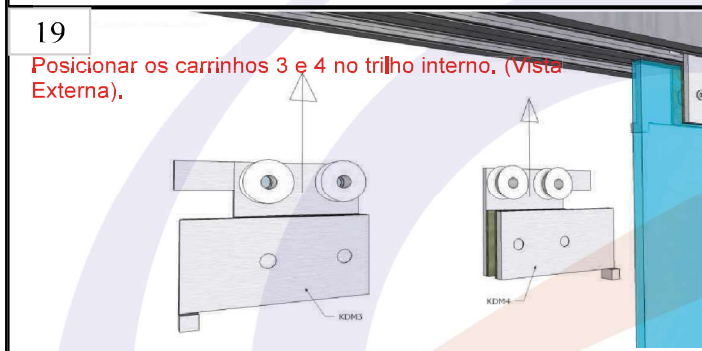

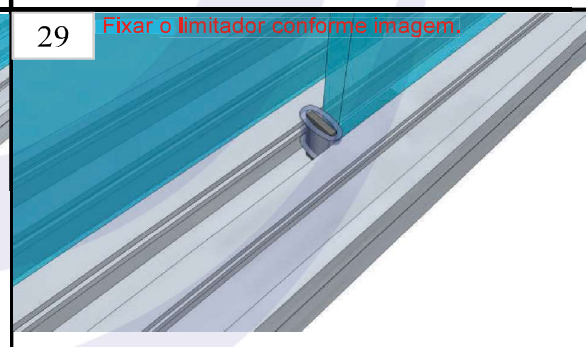
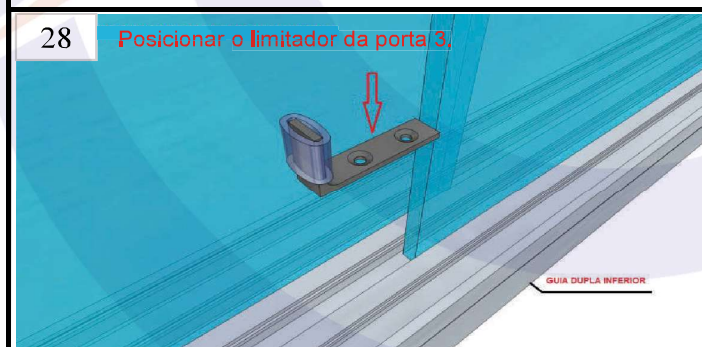
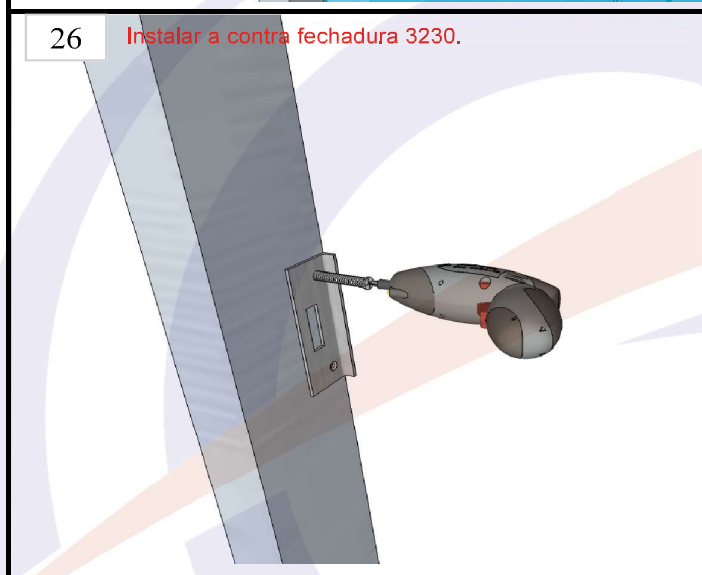
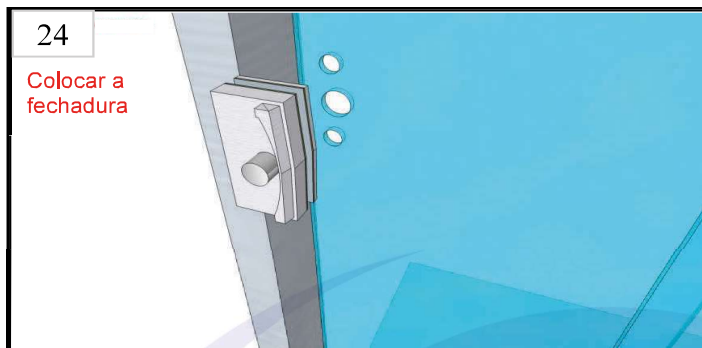



KIT Nº 1 - PORTA SIMPLES PIVOTANTE

- 01 PÇ 1201SG
- 01 PÇ 1101SG
- 01 PÇ 1103SG
- 01 PÇ 1013SG
- 01 PÇ 1520G
- 01 PÇ 1504AG

Dimensões máximas recomendadas: 1000x2200mm, 900x2600mm



KIT Nº 2 - JANELA PIVOTANTE

- 02 PÇS 1201SG
- 02 PÇS 1230G
- 01 PÇ 1335G
- 01 PÇ 1038G

Dimensões máximas recomendadas: 800x700mm

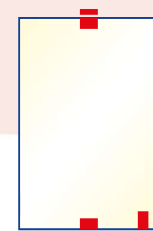

KIT Nº 3 - JANELA DE CORRER COM 4 FOLHAS

- 02 PÇS 1038BG
- 02 PÇS 1335G
- 02 PÇS 1629JG

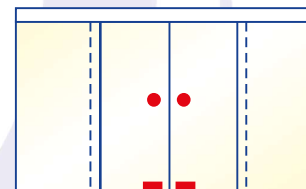

KIT Nº 4 - JANELA DE CORRER COM 2 FOLHAS

- 01 PÇ 1038BG
- 01 PÇ 1335G
- 01 PÇ 1629JG

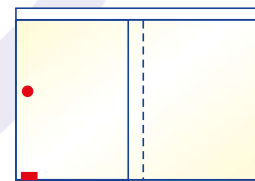

KIT Nº 5 - BOX DE ABRIR VA

- 02 PÇS 1114G
- 01 PÇ 1629BG

Dimensões máximas recomendadas: 600x1900mm





KIT Nº 6 - BASCULANTE VA PEQUENO

- 02 PÇS 1201SG
- 02 PÇS 1230G
- 01 PÇ 1523G
- 01 PÇ 1801G
- 01 PÇ 1003
- 02 PÇS 1003A
- 01 PÇ 1005G

Dimensões máximas recomendadas: 800x700mm

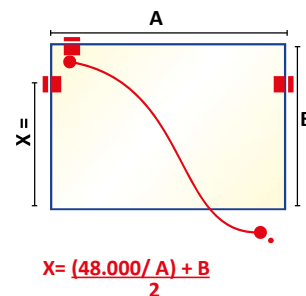

KIT Nº 7 - BASCULANTE VA GRANDE

- 02 PÇS 1201SG
- 02 PÇS 1231
- 01 PÇ 1523G
- 01 PÇ 1801G
- 01 PÇ 1003
- 02 PÇS 1003A
- 01 PÇ 1005G

Dimensões máximas recomendadas: 1000x800mm

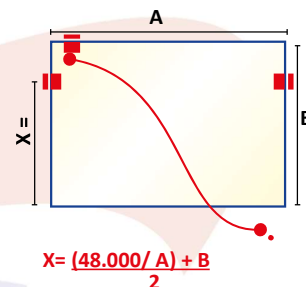

KIT Nº 8 - PORTA DUPLA PIVOTANTE

- 02 PÇS 1201SG
- 02 PÇS 1101SG
- 02 PÇS 1103SG
- 02 PÇS 1013SG
- 01 PÇ 1520G
- 01 PÇ 1531G
- 01 PÇ 1335G
- 01 PÇ 1038G

Dimensões máximas recomendadas: 1000x2200mm, 900x2600mm (cada folha)

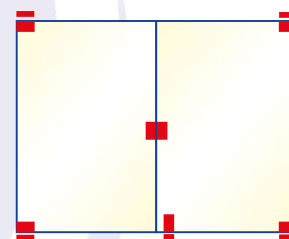

KIT Nº 9 - PORTA CORRER VIDRO VIDRO LINHA 3000

- 01 PÇ 3530G
- 01 PÇ 3534G

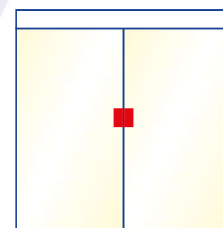

KIT Nº 10 - PORTA CORRER VIDRO ALVENARIA LINHA 3000

- 01 PÇ 3530G
- 01 PÇ 3230G





**KIT Nº 11 - JANELA CORRER VIDRO
VIDRO LINHA 3000**

01 PÇ 3532G
01 PÇ 3536G

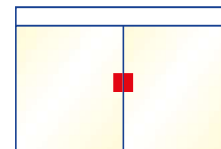

**KIT Nº 12 - JANELA CORRER VIDRO
ALVENARIA LINHA 3000**

01 PÇ 3532G
01 PÇ 3230G

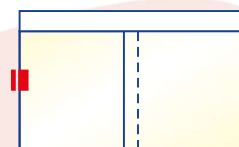

KIT Nº 13 - BASCULANTE VV PEQUENO

02 PÇS 1123G
02 PÇS 1230G
01 PÇ 1523G
01 PÇ 1801G
01 PÇ 1003
02 PÇS 1003A
01 PÇ 1005G

Dimensões máximas recomendadas: 800x700mm

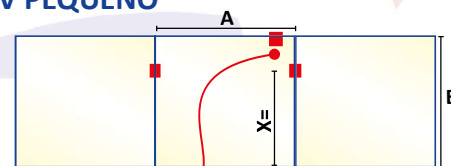

$$X = \frac{(48.000 / A) + B}{2}$$



KIT Nº 14 - BASCULANTE/FIXO BASCULANTE

02 PÇS 1201SG
04 PÇS 1230G
02 PÇS 1123G
02 PÇS 1523G
02 PÇS 1801G
02 PÇS 1003
04 PÇS 1003A
02 PÇS 1005G

Dimensões máximas recomendadas: 800x700mm

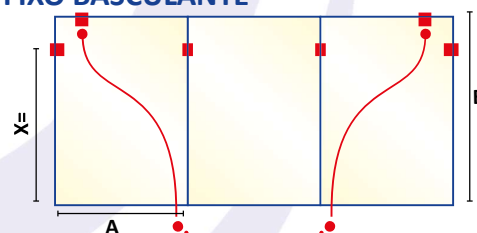

$$X = \frac{(48.000 / A) + B}{2}$$



KIT Nº 15 - PORTA PIVOTANTE

01 PÇ 1101PGA
01 PÇ 1103PGA
01 PÇ 1201G



KIT Nº 16 - PORTA PIVOTANTE

01 PÇ 1201SG
01 PÇ 1101SG
01 PÇ 1013SG
01 PÇ 1520MAG
01 PÇ 1M520ML
01 PÇ 1506AUG

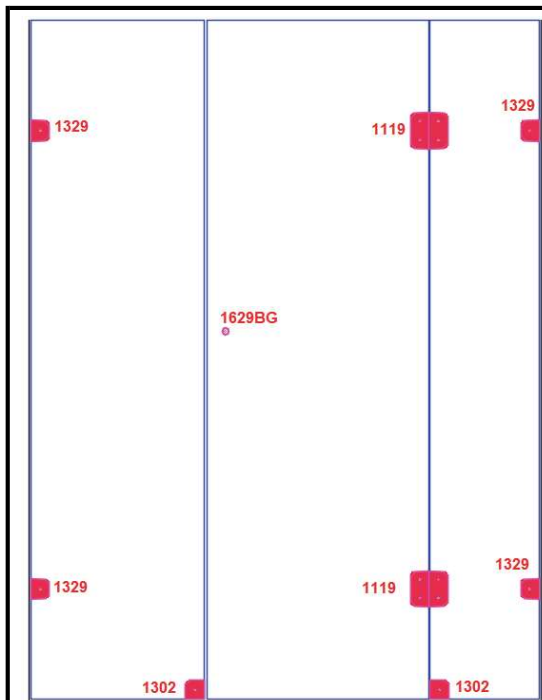

Box de Abrir com 2 fixos laterais e dobradiça Vidro/Vidro.
Dimensões máximas da porta 650 x 1900.
Medidas maiores consultar o dpto Técnico.

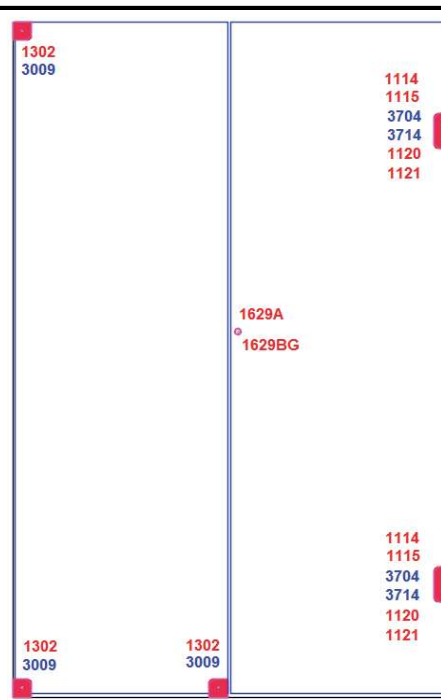

Box de Abrir com 1 fixo lateral e dobradiça Vidro/Alvenaria
Dimensões máximas da porta:
1114/1115/3704 = 600 x 1900
3714 = 500 x 1900
1120/1121 = 650 x 1900

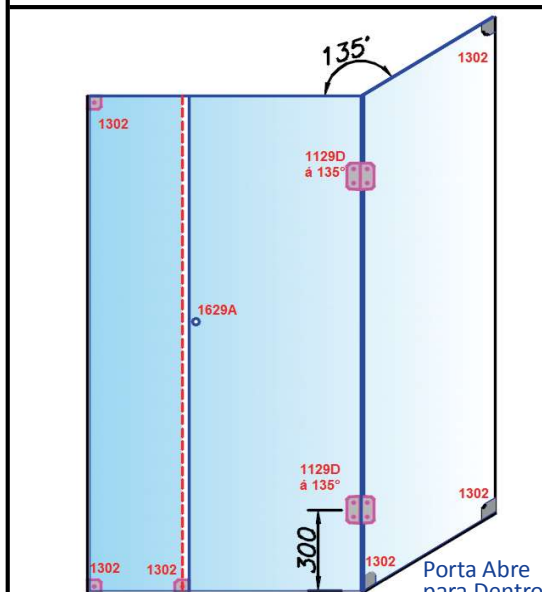

Box de Abrir de canto à 135° com dobradiça Vidro/Vidro.
Dimensões máximas da porta 600 x 1900.
Medidas maiores consultar o dpto Técnico.

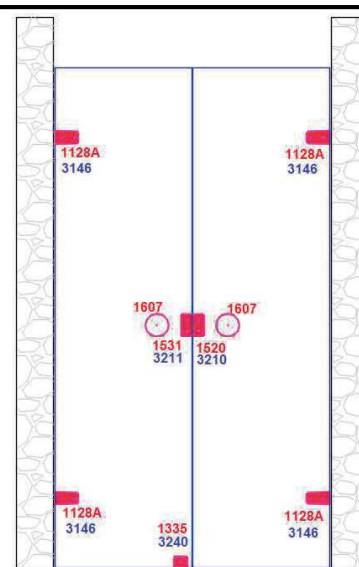

Porta de abrir com dobradiça de batente Vidro/Alvenaria
Dimensões máximas da porta 1000 x 2100
Medidas maiores consultar o dpto Técnico.

LEGENDA

- Santa Marina
- Linha 3000

SOLUÇÕES INTELIGENTES

Porta de abrir Gigante com dobradiças PG, 1128A na lateral para segurança da instalação (Evita a flambagem do vidro). Carrinho CP na borda inferior do vidro para ajudar na sustentação e evitar escorregamento do vidro. Dimensão Máxima - 1400 x 3000. Medidas maiores consultar o dpto técnico.

SOLUÇÕES INTELIGENTES

Conjunto de portas sanfonada com 4 folhas, dobrando 2 para cada lado. Dimensão máxima das folhas 800 x 2100. Medidas maiores consultar o dpto técnico.

VISTA DE PLANTA

Conjunto com porta de abrir e Fixos. Dimensão máxima da porta 900 x 2600 ou 1000 x 2200. Medidas maiores consultar o dpto técnico.

Conjunto com porta de abrir e Fixos. Dimensão máxima da porta 900 x 2600 ou 1000 x 2200. Medidas maiores consultar o dpto técnico.

SOLUÇÕES INTELIGENTES

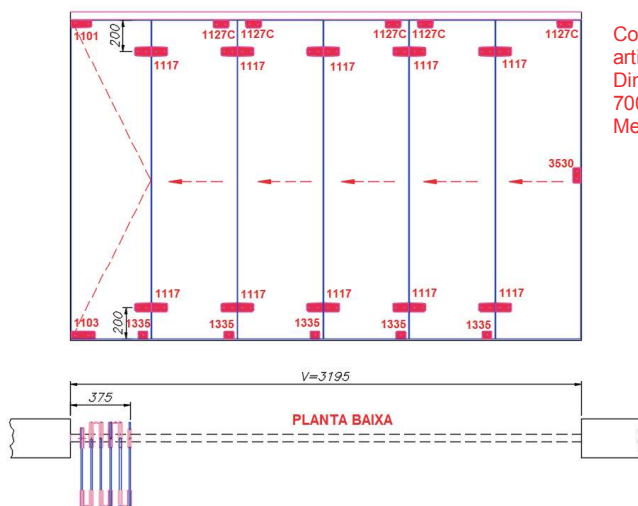

Conjunto de porta camarão com 6 peças articuladas em vidro 8 ou 10mm.
Dimensão máxima recomendada por folha: 700 x 2100.
Medidas maiores consultar o dpto técnico.

PROLONGADOR REFORÇADO

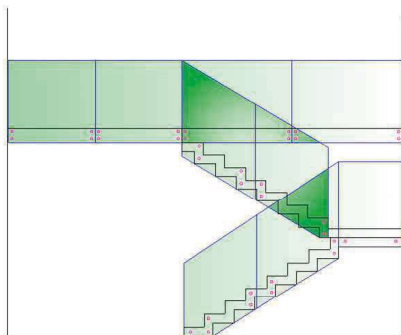

Guarda corpo em vidro Laminado e temperado, fixado com Prolongador Reforçado PL-R.
Cada Prolongador suporta 12kg e vidros de espessura de 8 a 12mm.
Entrar em contato com dpto técnico para especificação corretamente.
Guarda corpo de vidro devem obedecer as normas NBR 7199 E NBR 14718.

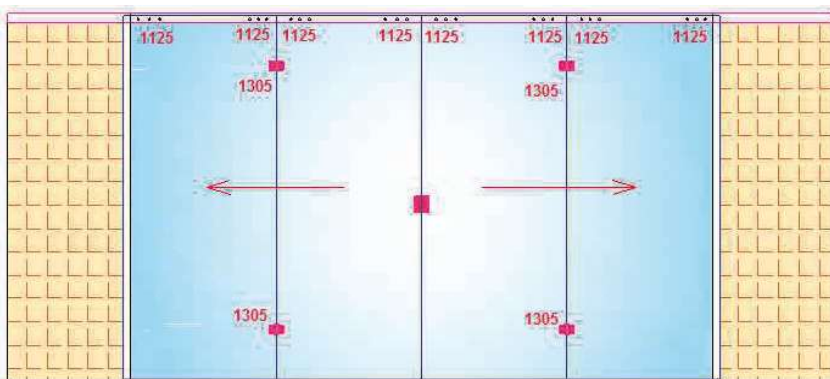

Conjunto de porta de correr por de trás da parede.
União de 2 peças através do suporte 1305 para aumentar o tamanho da folha com mais segurança, permitindo uma maior abertura do vão.
Dimensões máximas entrar em contato com dpto técnico.

LEGENDA

- Santa Marina
- Linha 3000

1001 e 1002

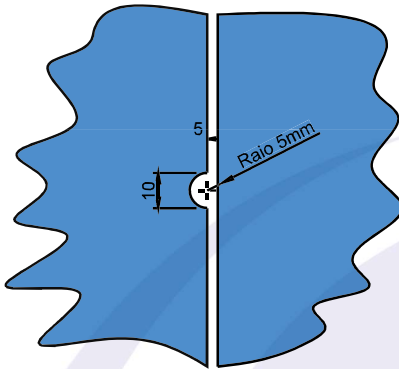

1007A e 1008A

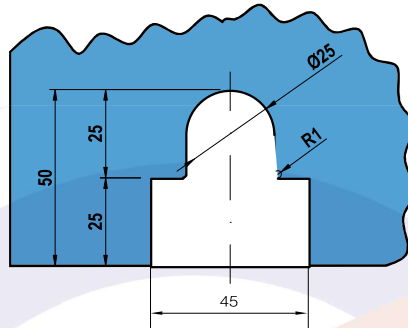

1007 e 1008

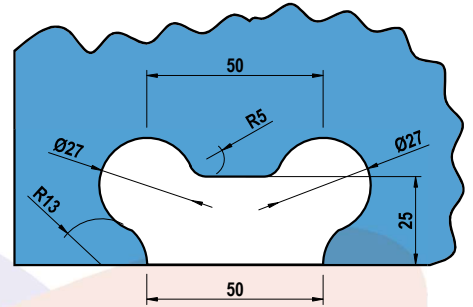

1100 e 1100I

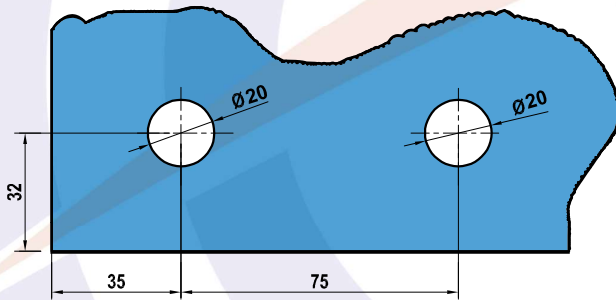

1101 PG, 1203 PG e 1101PGA

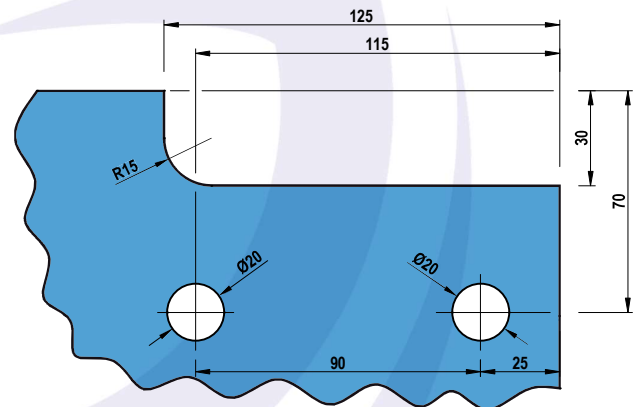

103PG e 1103PGA

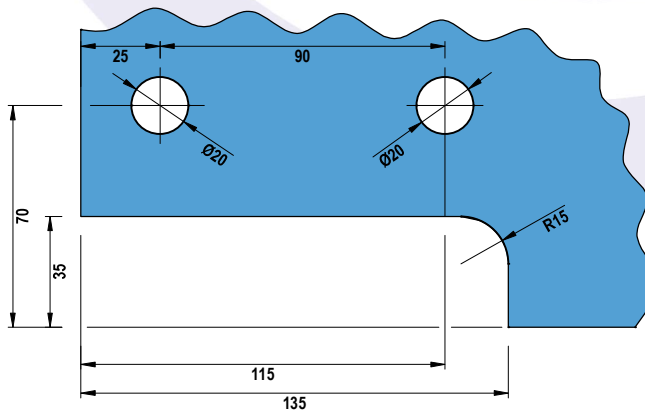

1101, 1103R e 1103RM

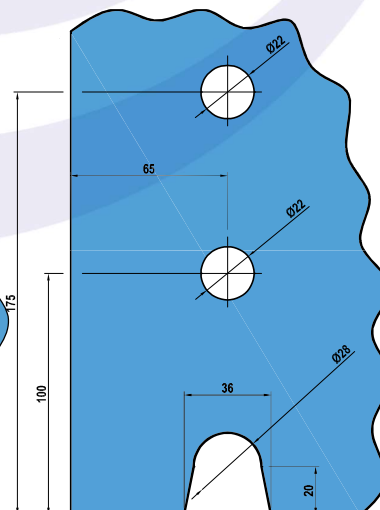

1101, 101s, 102, 104, 105, 106, 107, 124,
203, 206, 207, 209, 210, 211, 212, 213,
214, 215, 216, 217, 218, 219, 220, 221,
222, 223 e 224

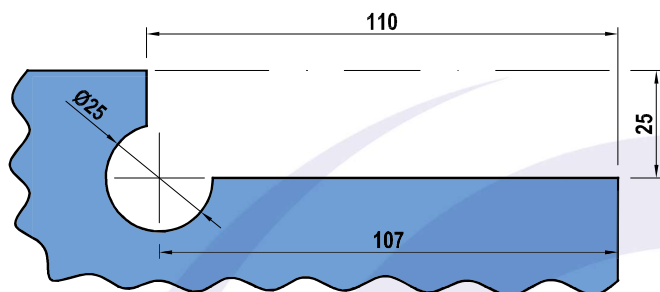

1103, 103s, 108 e 109

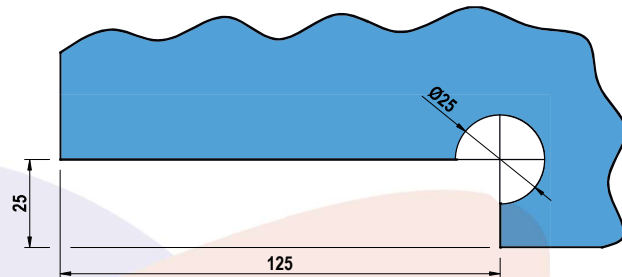

1110, 112, 113, 112F e 229

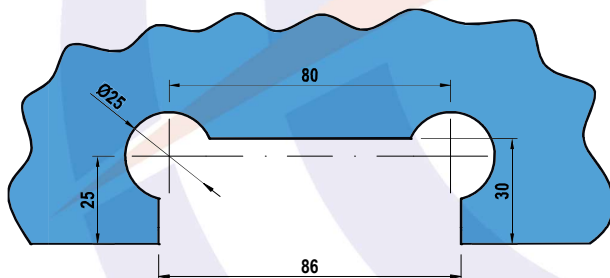

1114, 115, 129 e 1114A

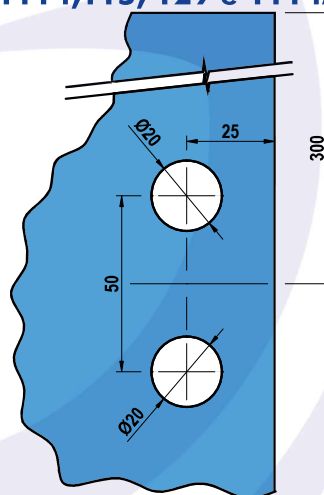

1116

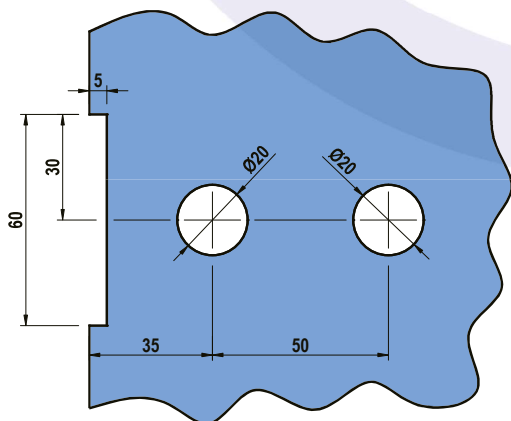

1114BG

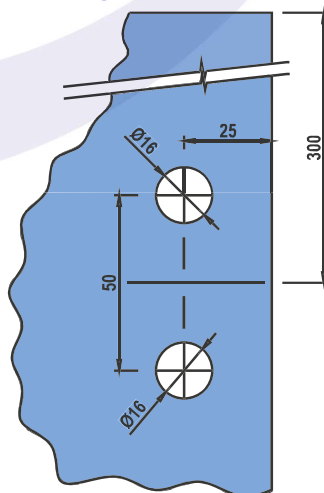

1117

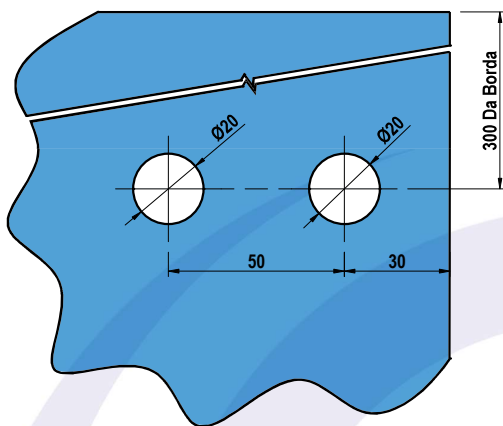

1118

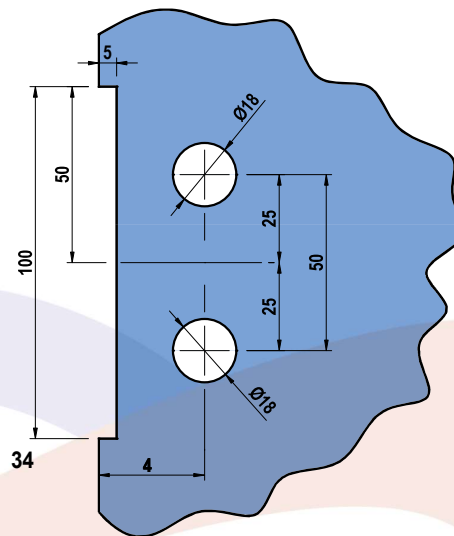

1118 D

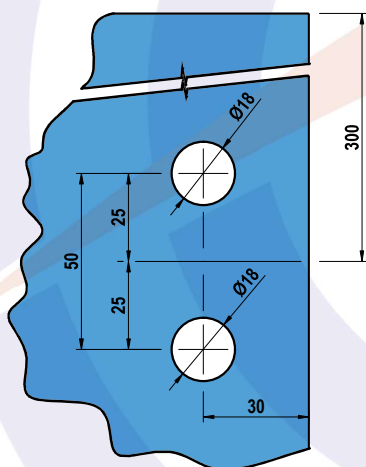

1119

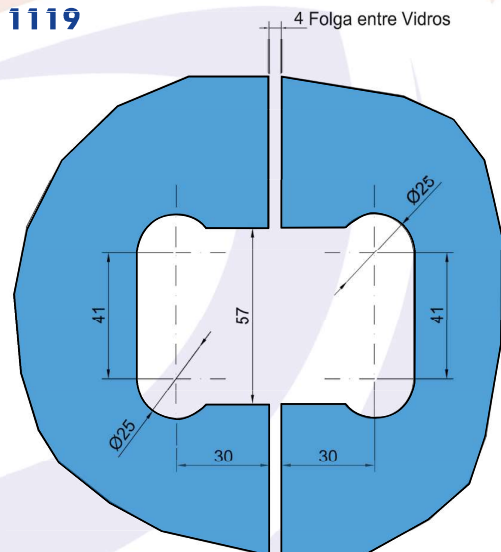

1120 e 1121

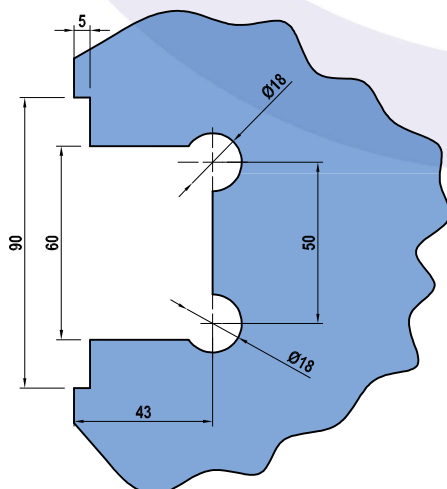

1122 A e 1122AC

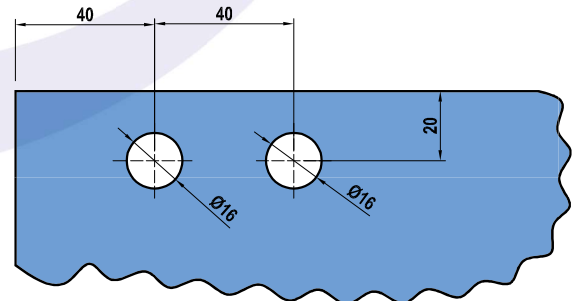

1122 A M e 1122AMC

1123 MINI, 230M e 329M

1123, 123A, 230, 329, 335A, 402, 528, 529, 530 e PC

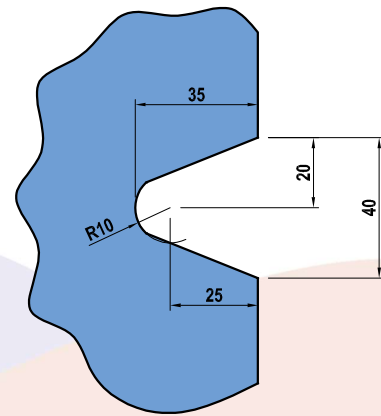
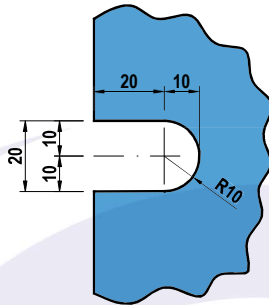
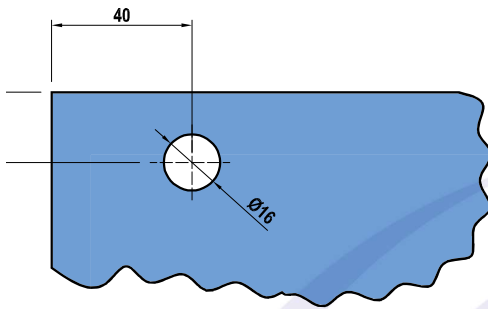

1125 e 1125D

1126, 126D, 126C, 126DC e 1126QC

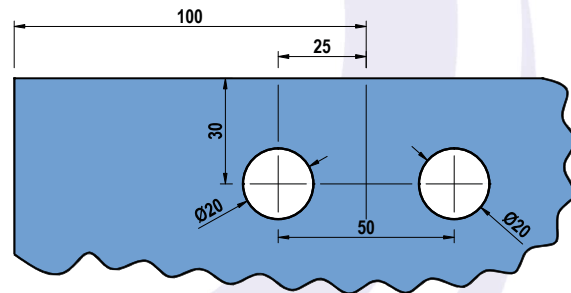
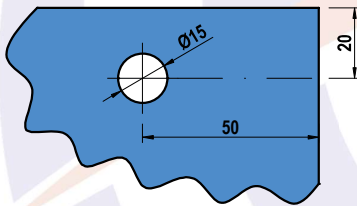

1126 B

1126 M e 126 MC

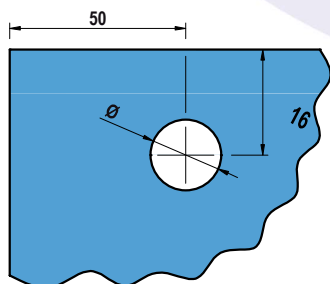

20

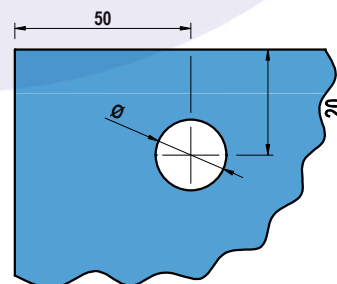

1127, 127A e 127B

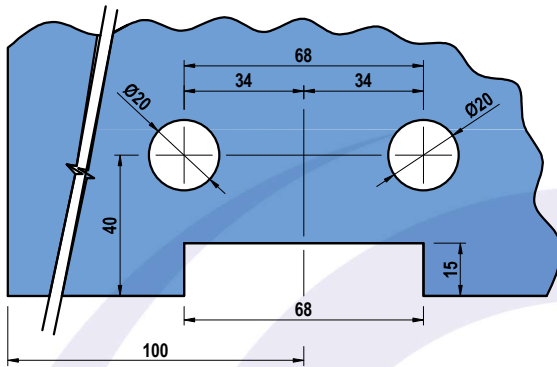

1128A e 128B

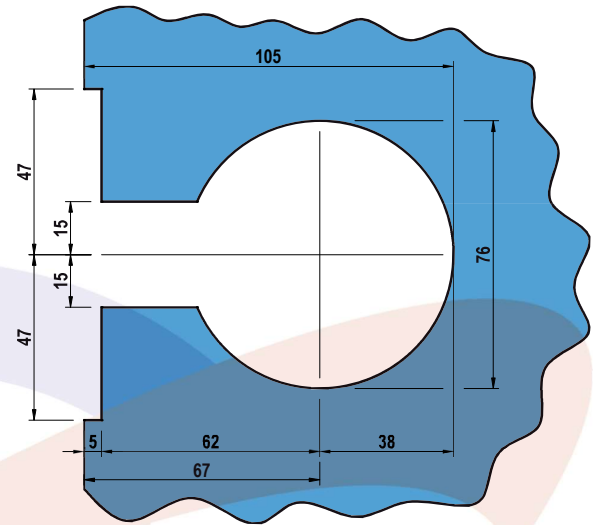

1128 C

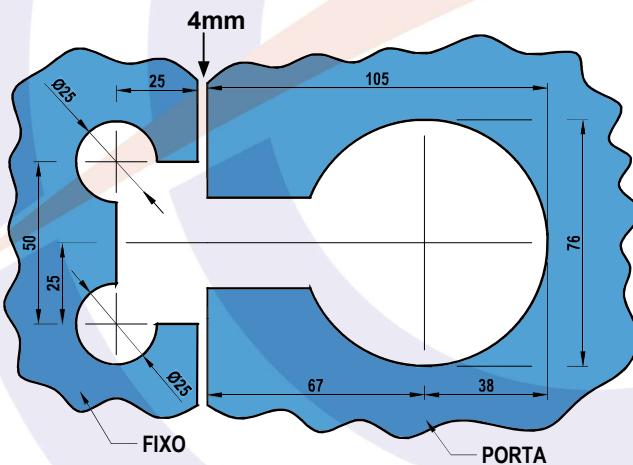

1129 à 90° - Porta e Fixo

COLANTE

PASSANTE

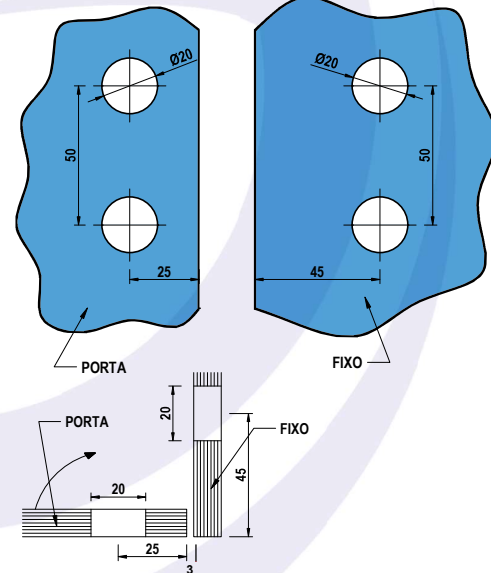

1129 à 135° - Porta e Fixo

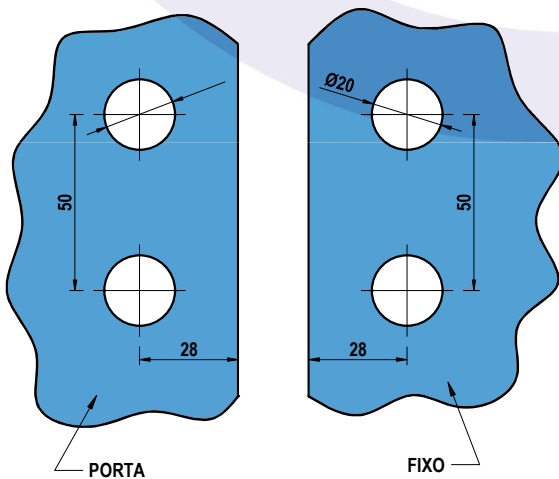

1130, 209, 210 a 219, 231, 306, 308, 310, 310a, 310b, 311, 311a, 311b, 312, 312a, 312b, 313, 313a, 314, 314a, 315 a 318, 318a, 319 (COLANTE), 324, 333, 334 e 519

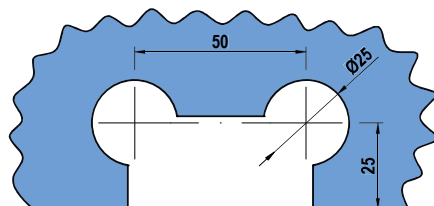

1131

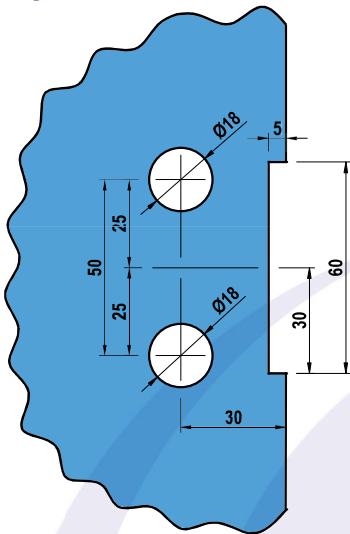

1132, 1132A, 1132B, 1132C e 1132D

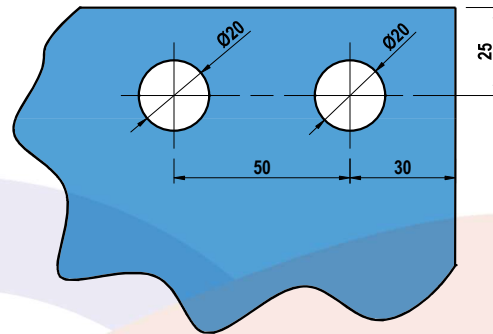

1136 MINI

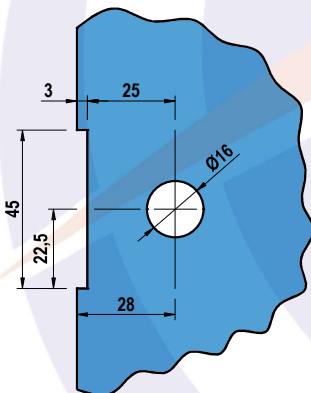

1136 e 1136B

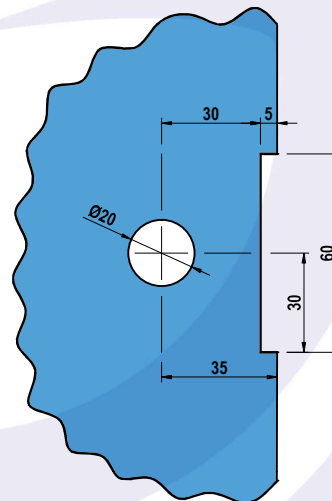

1137 MINI

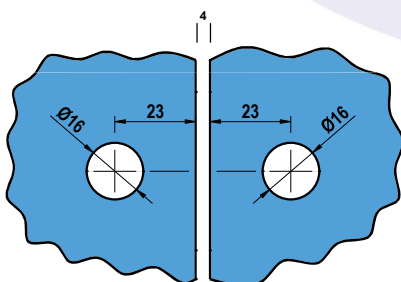

1137 e 1137 B

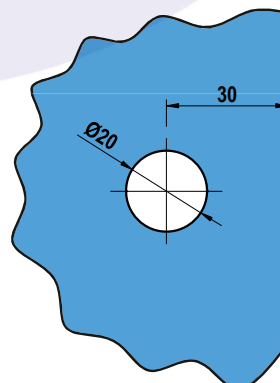

**1209, 210, 211, 213, 213, 214, 215,
216, 217, 218, 219, 220, 221, 222, 223
e 224**

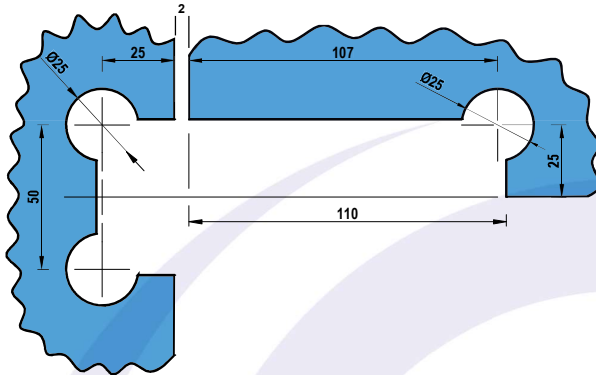

1209 a 90°

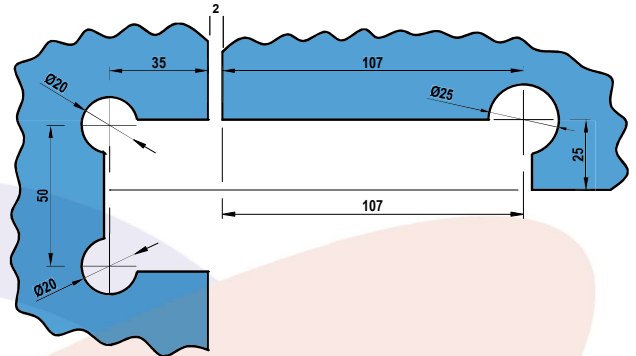

1209 À 135°

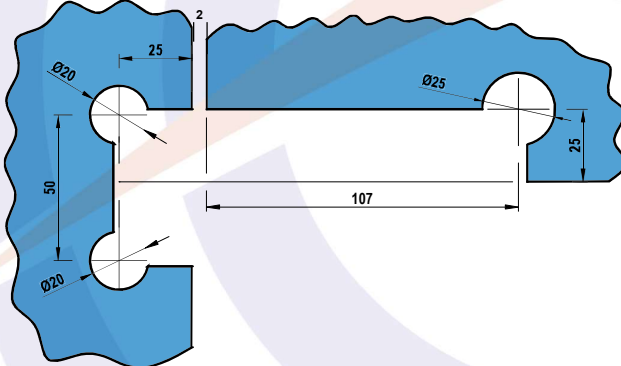

1209 PG

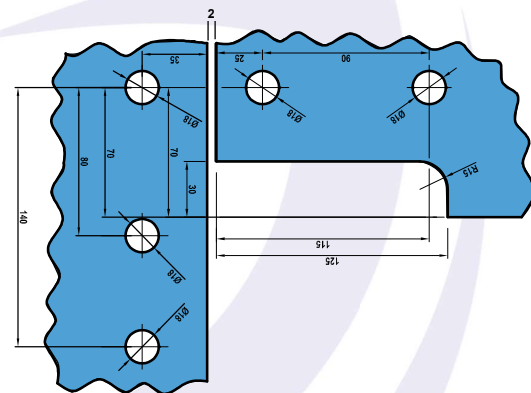

**1302 210, 211, 216, 217,
218, 219, 221, 222, 223,
224, 226, 227, 229, 301,
302, 303, 308, 309, 311,
311B, 312, 313, 314,
333, 334, 336, 513, 522,
525 e 526**

**1302A (ANTIGA), 209 à
224, 306, 308, 310, 310A,
310B, 311, 311A, 311B,
312, 312A, 312B, 313,
313A, 314, 314A, 315,
316, 317, 318, 318A, 324,
325, 333, 334 e 325**

1225, 1226, 1227

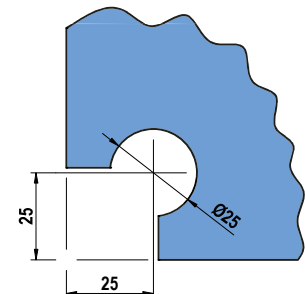
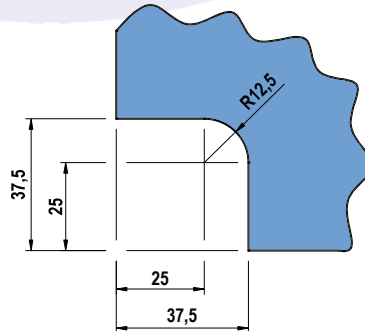
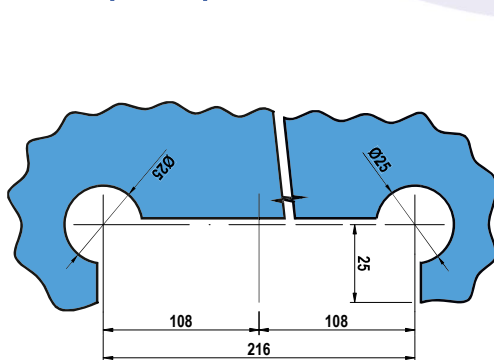

1304,305, 307 e 323

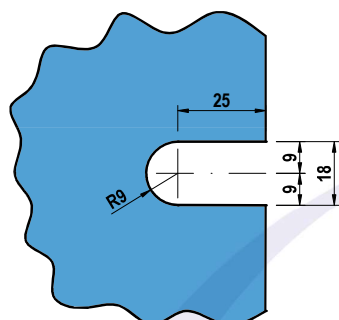

1304 com furo

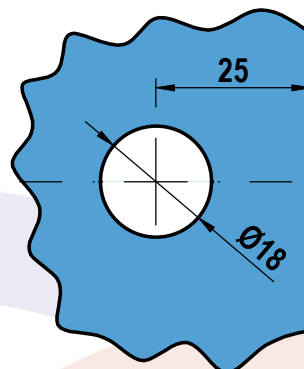

1310 À 90°

PASSANTE

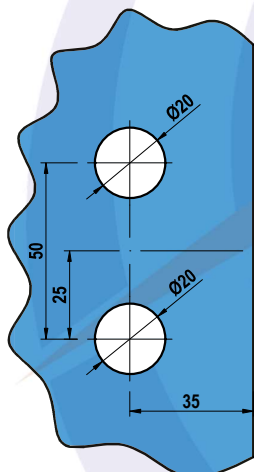

COLANTE

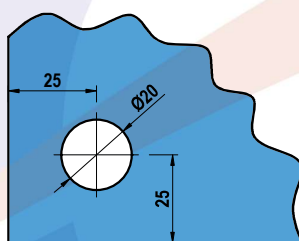

1310 À 135°

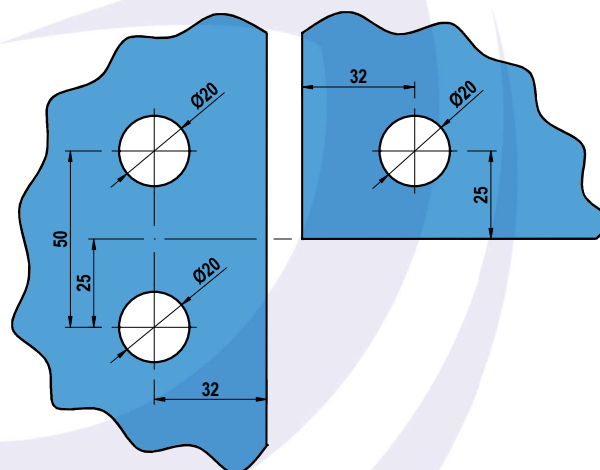

1310 e 1315

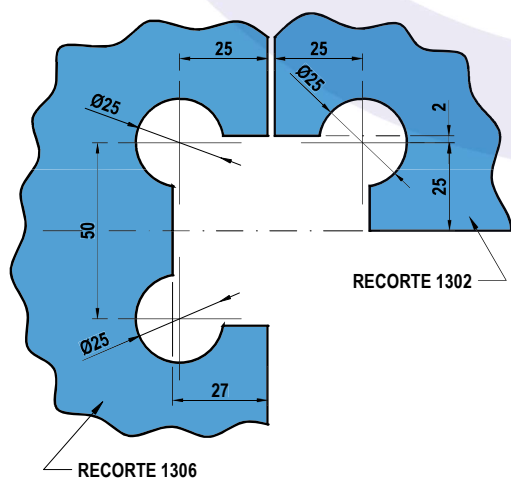

1316

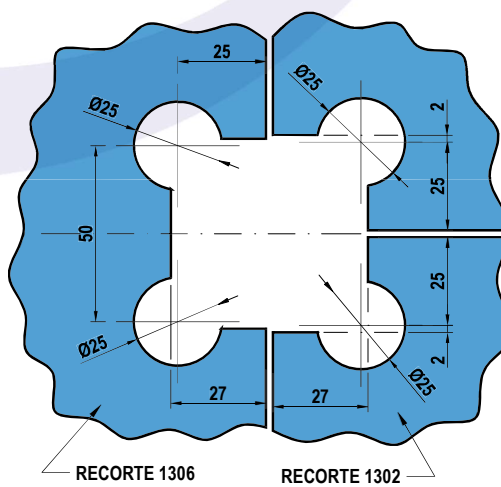

1319 À 135°

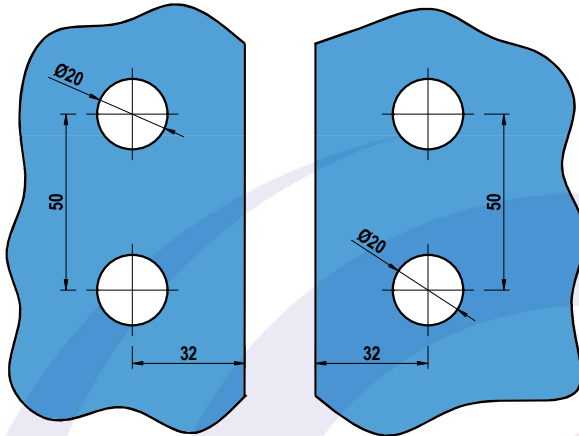

1319

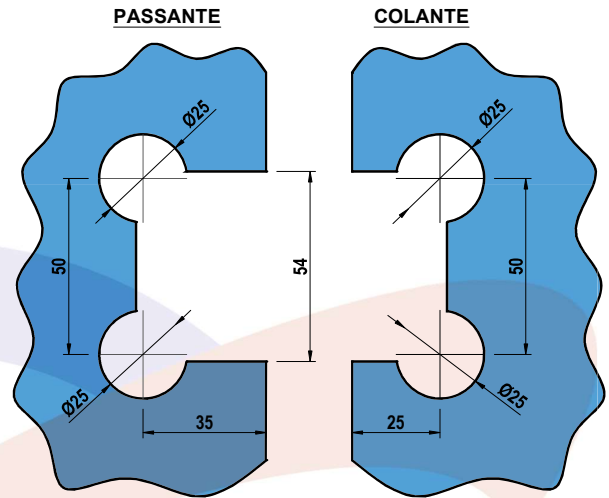

1320 À 135°

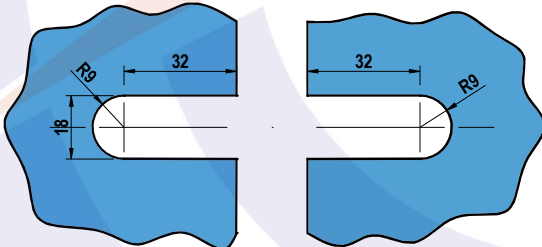

1320, 1323 e 1330

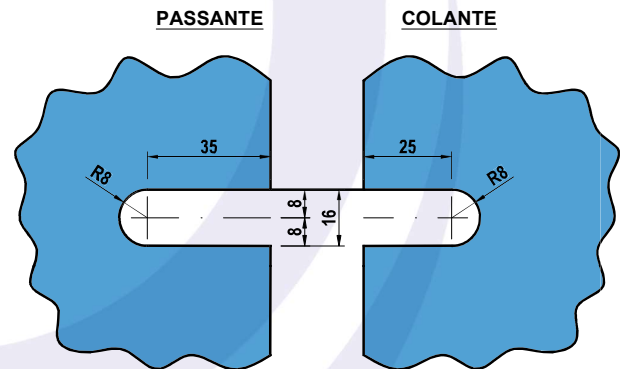

1321 À 135°

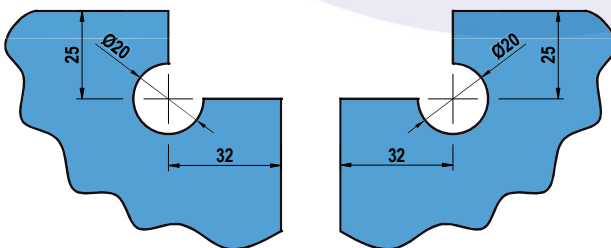

1321

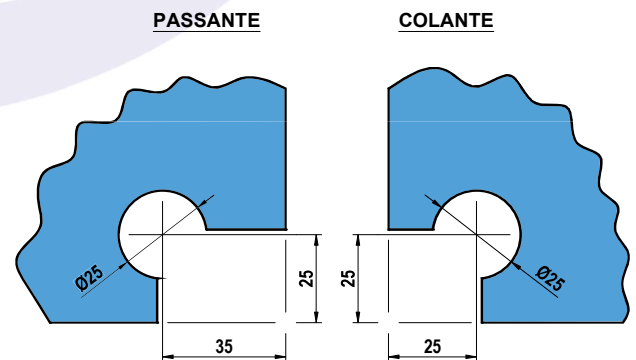

1322 À 135°

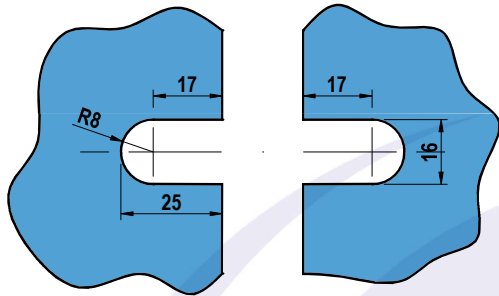

1322 e 3730

PASSANTE

COLANTE

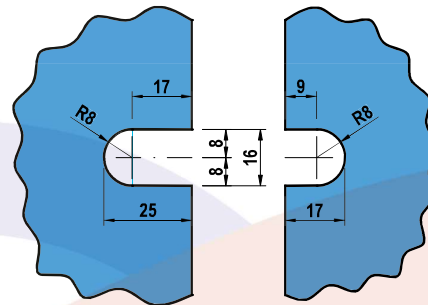

1326

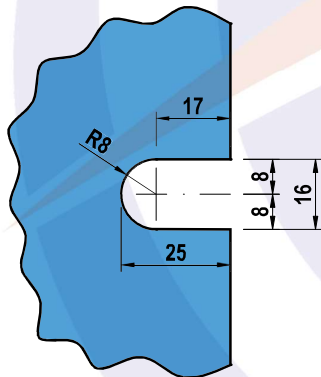

1335-GUIA EMBUTIDA

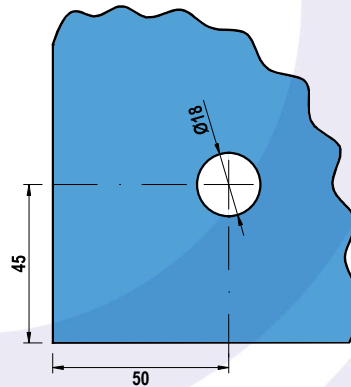

1335-GUIA LIVRE, 1335C e 1871FG

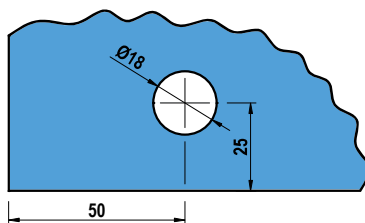

1335 MINI - PORTA DE ABRIR e 1335 C Mini

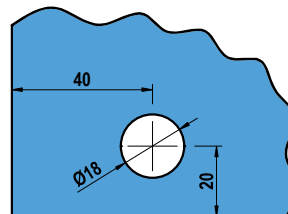

1335 MINI - PORTA DE CORRER

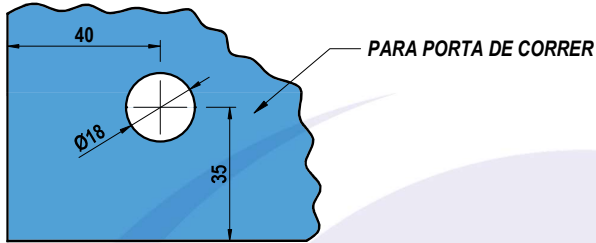

1510, 510D, 510E, 511, 511D e 511E

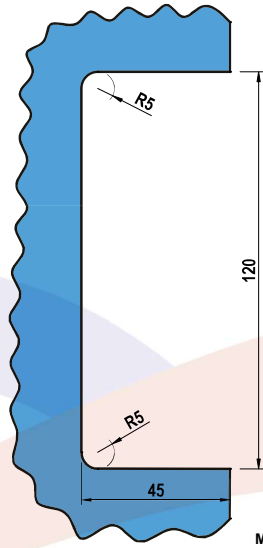

1519

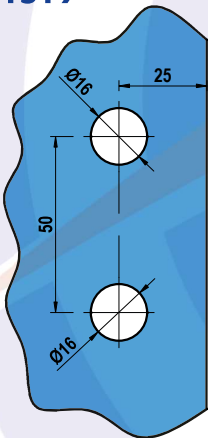

502, 504, 508, 519, 520, 520AG 520TT, 520PX, 531, 531PX e CP

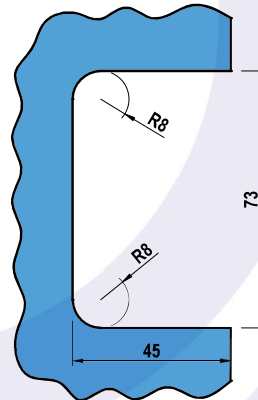

1520MLG, 1520MPG e 1507G

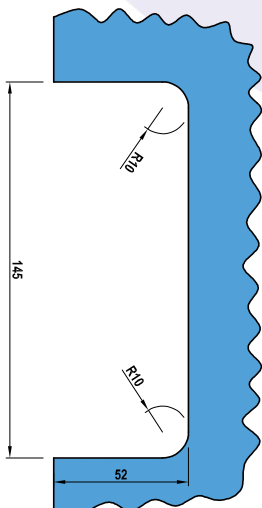

1523 e 1524

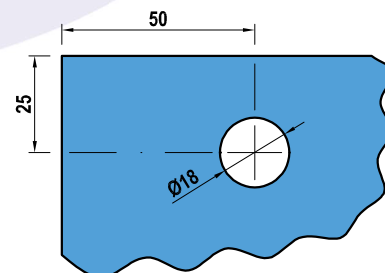

1523MINI, 524M e 335CM

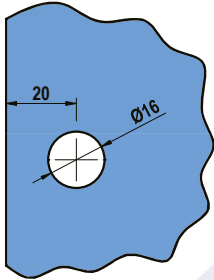

1527 e1521

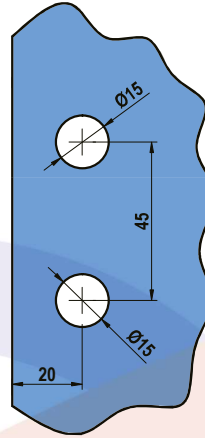

1629MINI e 629JM

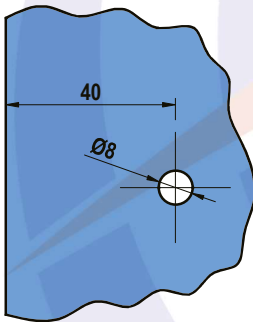

1800 FG com trilho

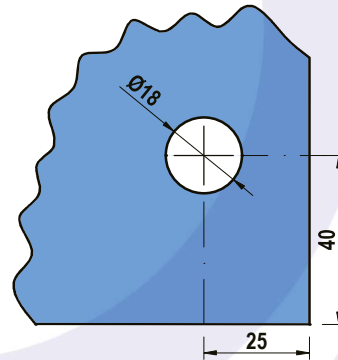

1800 FG sem trilho

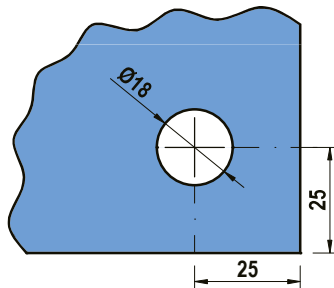

2009

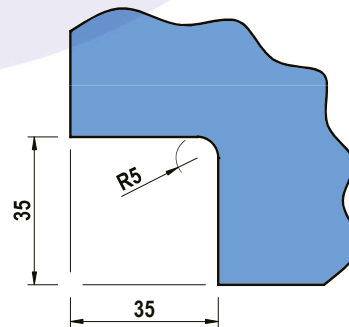

2010, 2405, 2406, 2410 e 2411

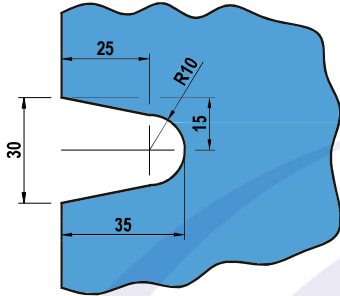

2110, 2122, 2140, 2002 e 2004

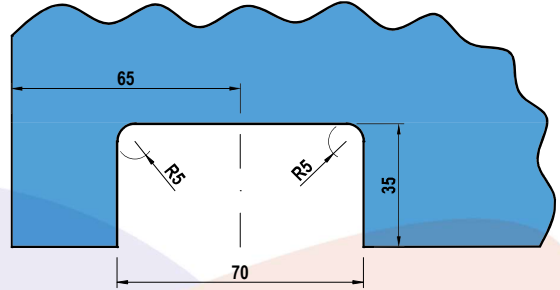

2132 e 2133

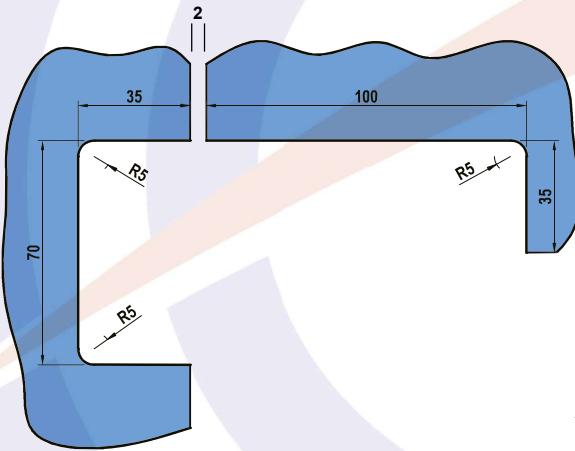

2132 e 2133

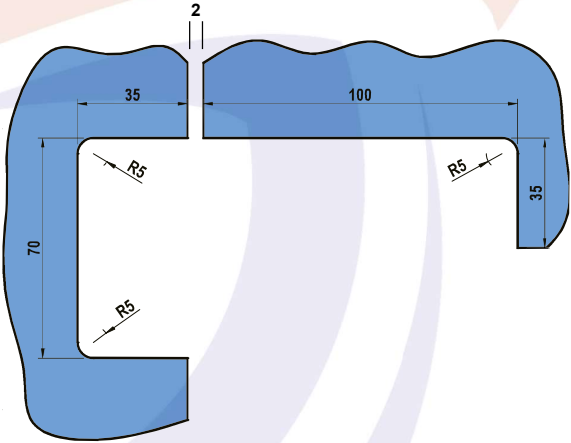

2210 e 2211

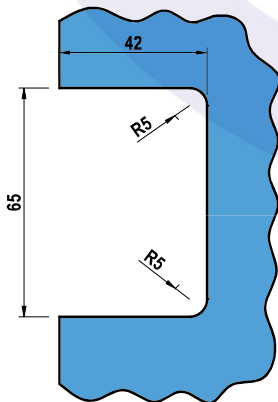

2210GRD e 2211GRD

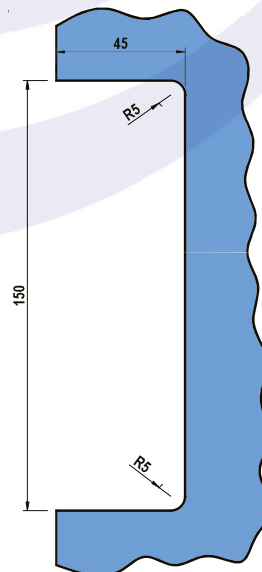

2240 e 2241

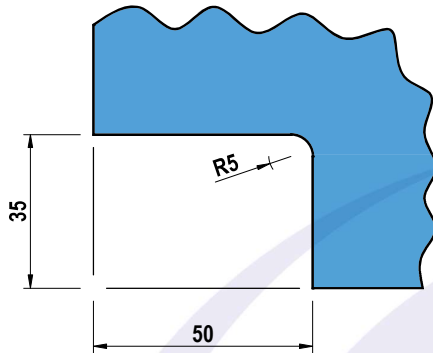

2401 e 2402

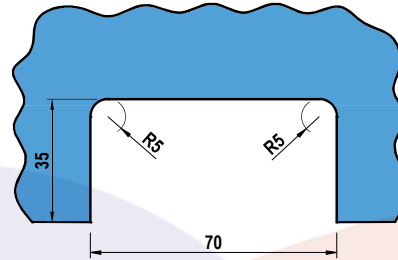

2520

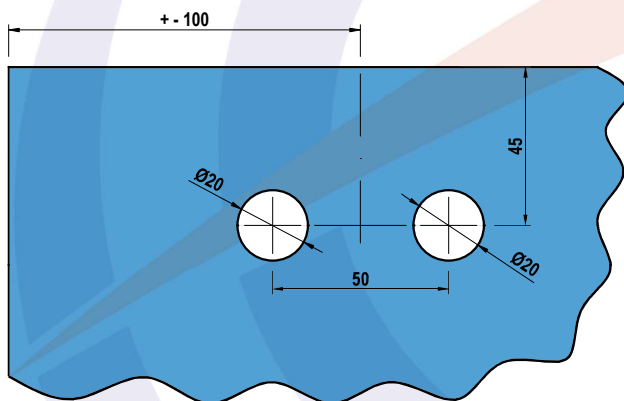

2701, 2702(COLANTE), 2703, 2704 e 2705

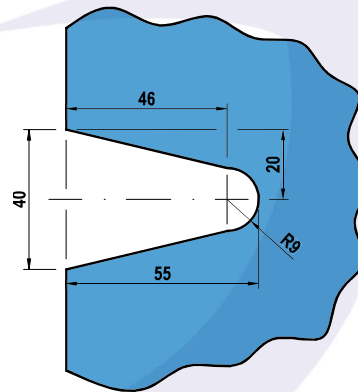

2702(PASSANTE)

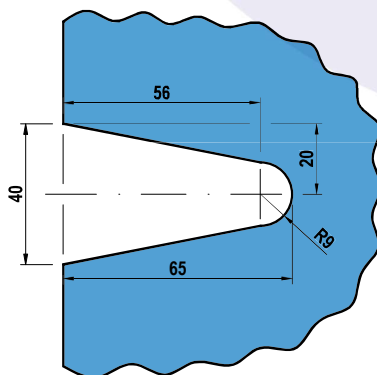

2708

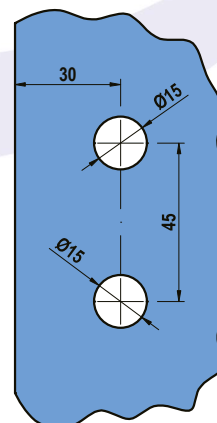

2720

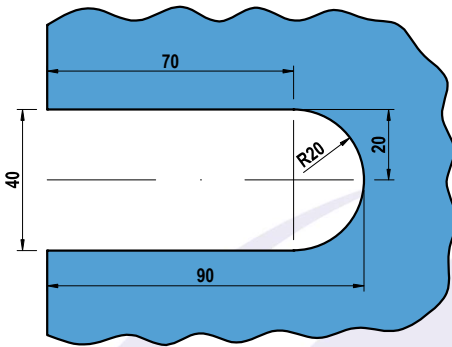

2721

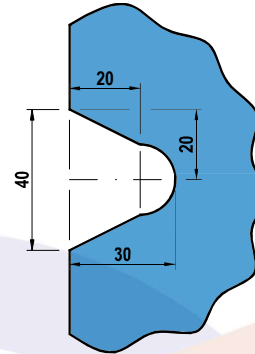

2730

PASSANTE

COLANTE

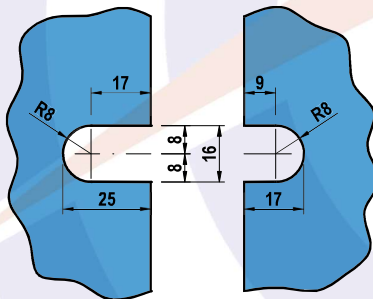

3001, 3002 e 3003

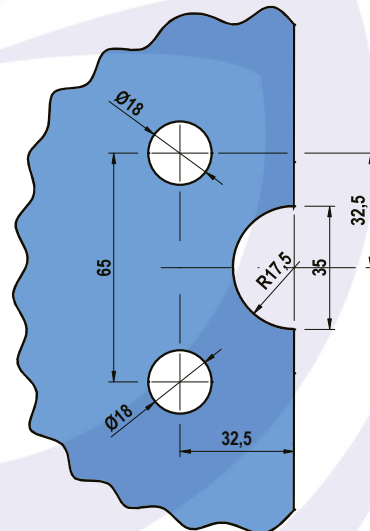

3004, 3253, 3410, 3411, 3713 e 3714

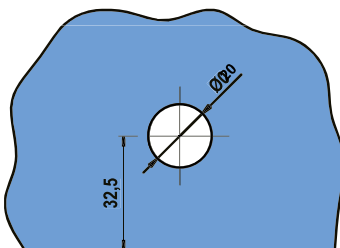

3006, 3007, 3010, 3013, 3438 e 3439

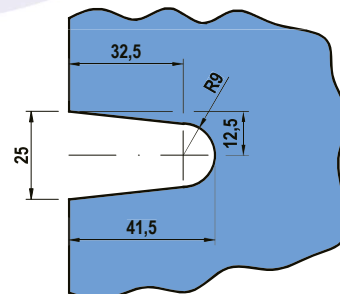

3009

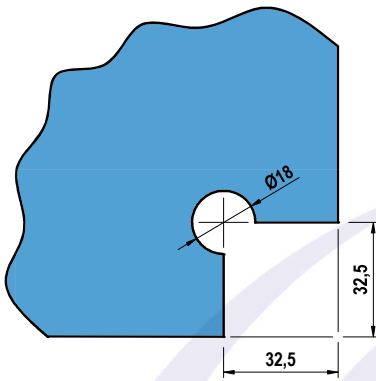

3014

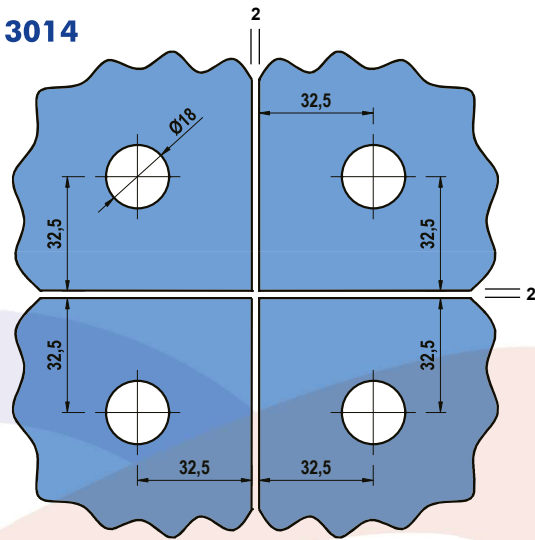

3016 e 3017

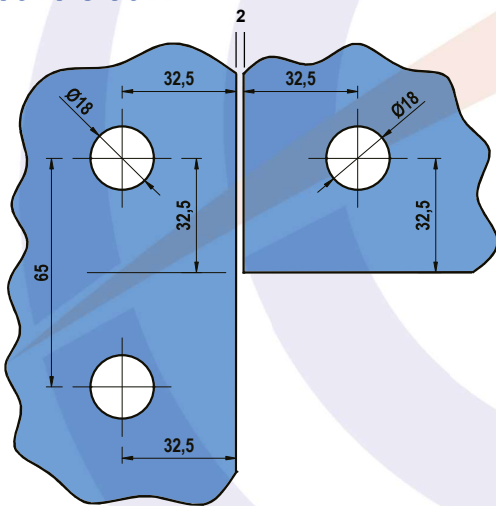

3022

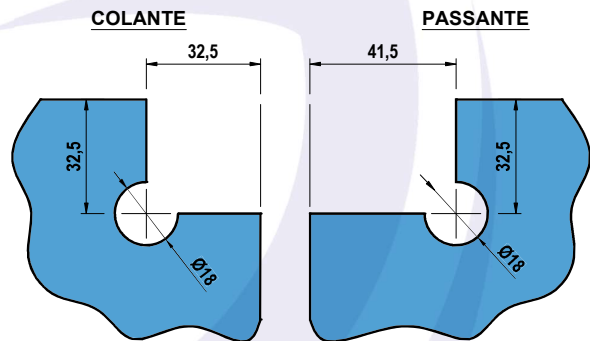

3023

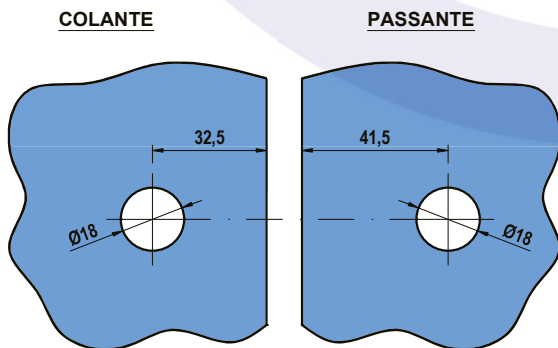

3025

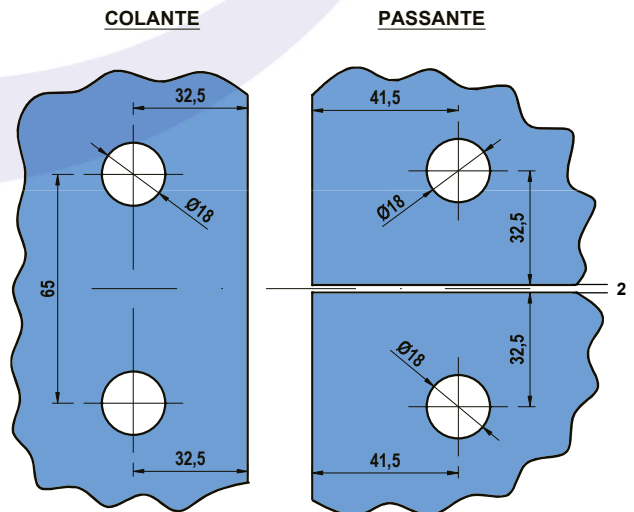

3110 e 3140

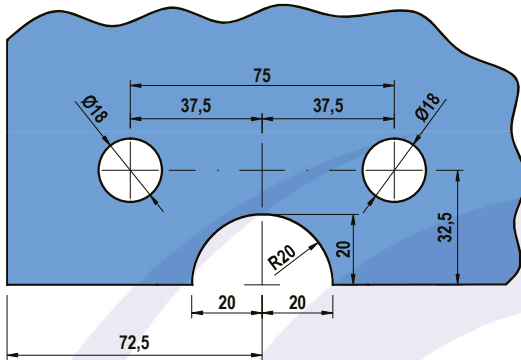

3122

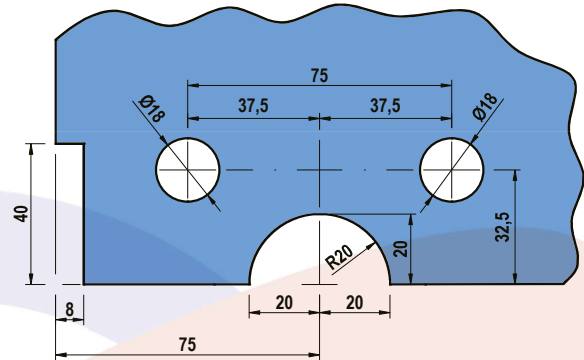

3123, 3141, 3401 e 3402

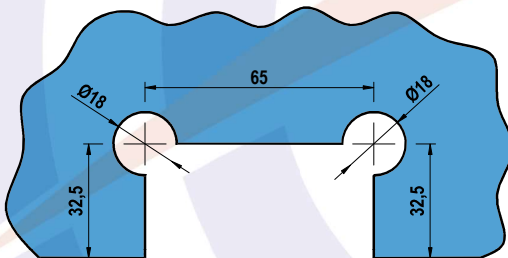

3132

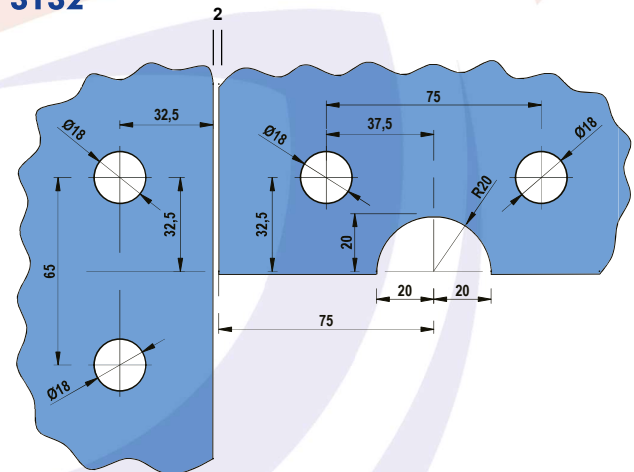

3143, 3701, 3702, 3703 e 3704

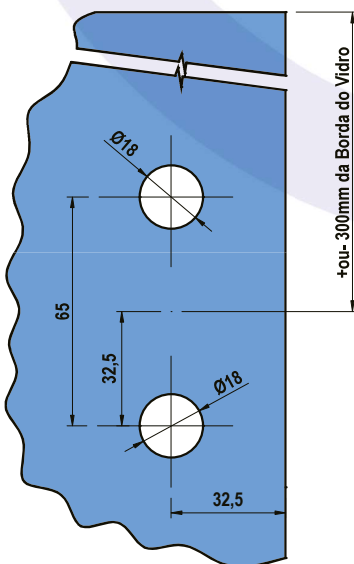

3144

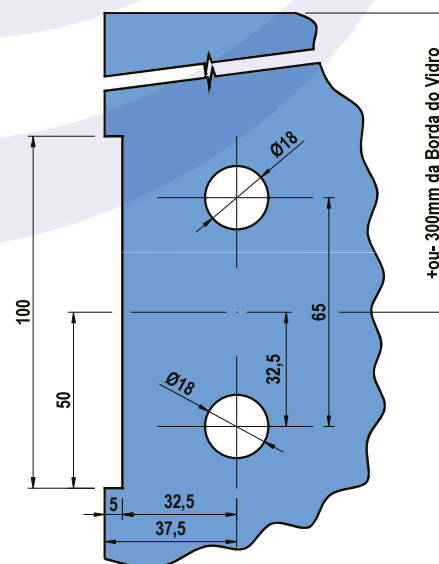

3145

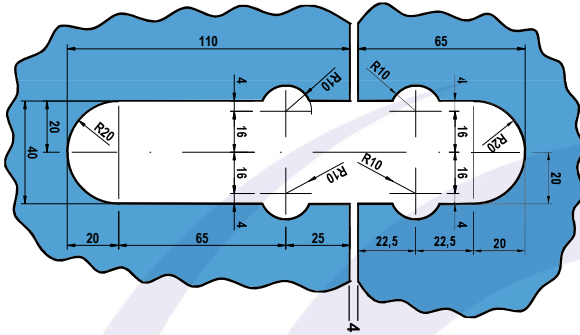

3146, 3147

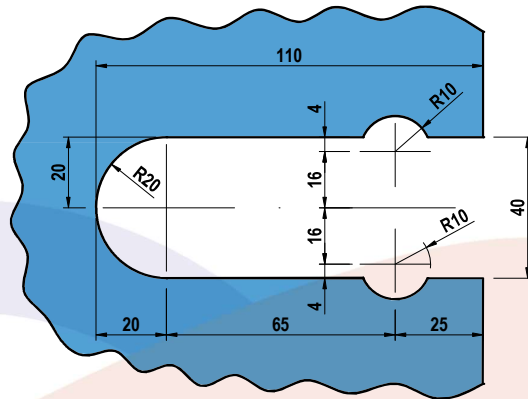

3210, 3530, 3530 A 135°

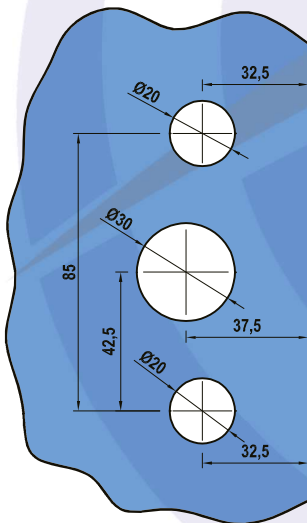

**3211, 3212, 3532, 3534, 3536,
3540, 3534 A 90, 3534 A 135°**

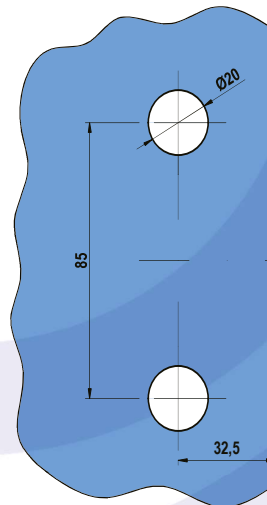

3215

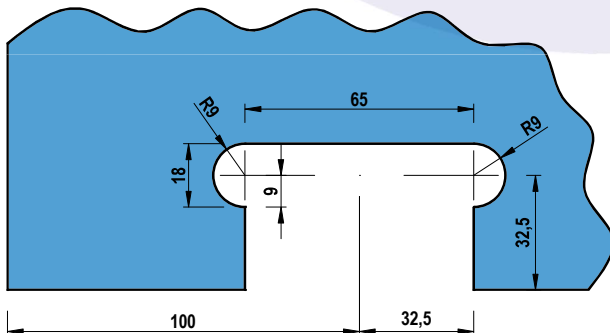

3240, 3539 PORTA DE CORRER

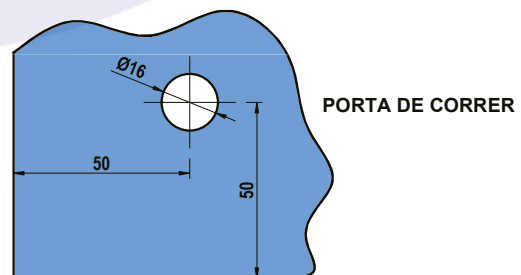

**3240, 3539
PORTA DE ABRIR**

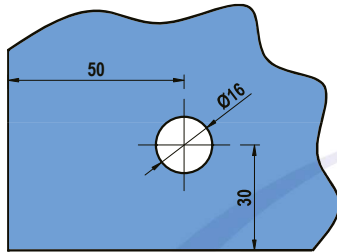

3250 e 3252

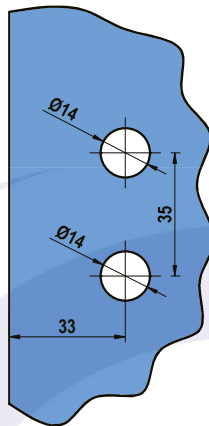

3431 V.A

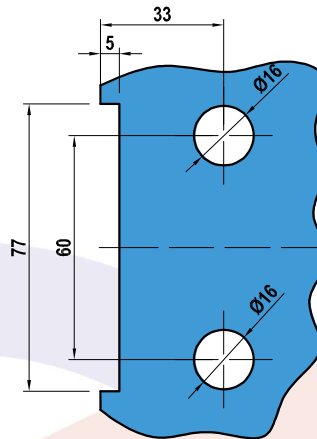

3431 V.V

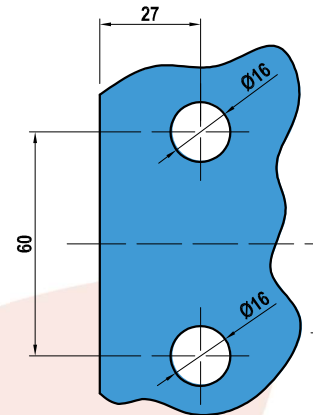

3530 e 3532 a 90°

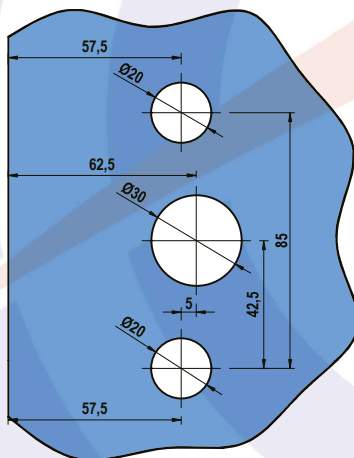

**3530M E 3210M - COM FURO CENTRAL
3532 JM, 3536 JM, 3434 M, 3211 M,
3535 E 3534 (SEM FURO CENTRAL)**

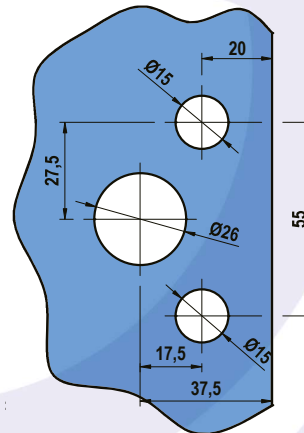

3713 e 3714

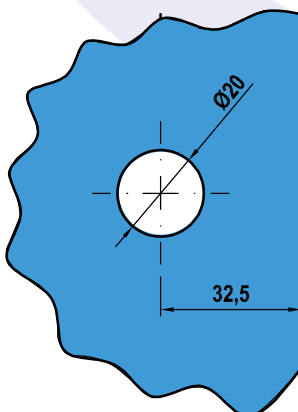

3715 e 3716

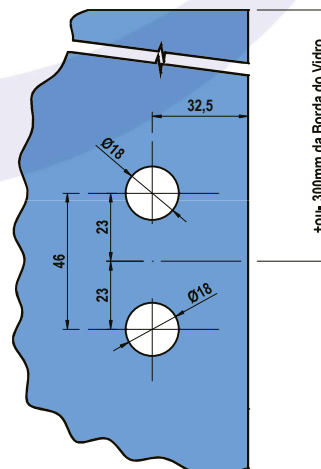

BF VV e BF VA

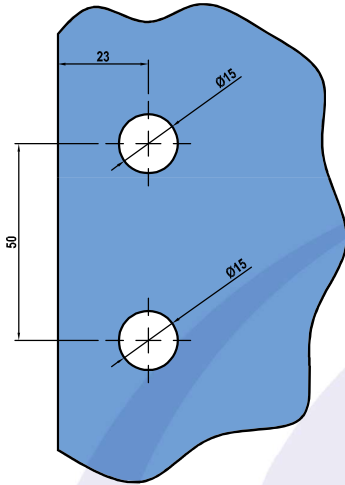

DM VV

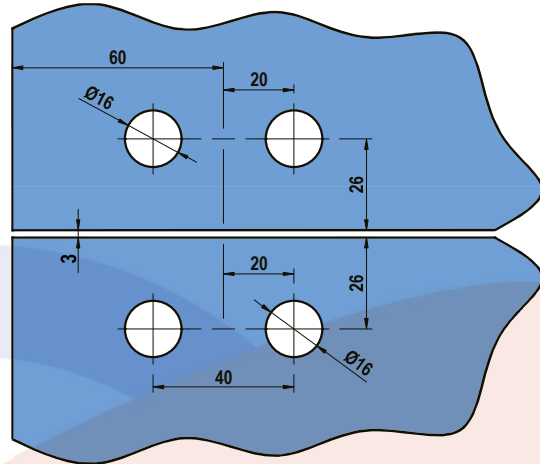

DMVA

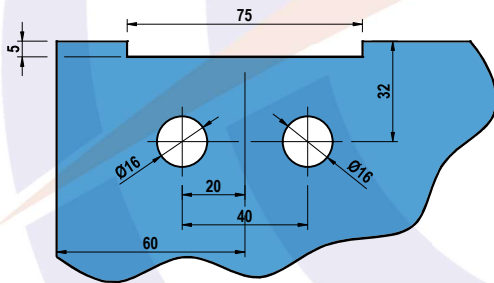

HT VV

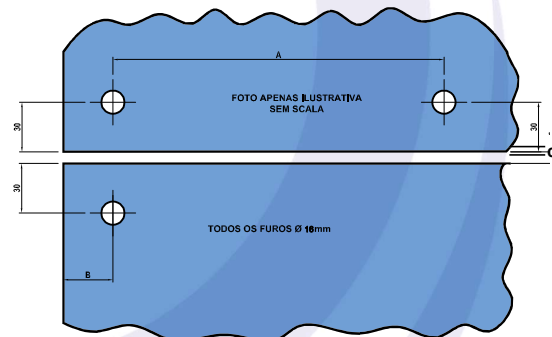

"A" - MEDIDA DA HASTE MENOS 50MM

"B" - LARGURA DO VIDRO MENOS A MEDIDA "A", DIVIDIDO POR DOIS (2) É IGUAL A DISTÂNCIA DA BORDA DO VIDRO AO EIXO DO FURO

"C" - FOLGA MÍNIMA 3MM E MÁXIMO 8MM

HT VV 2F

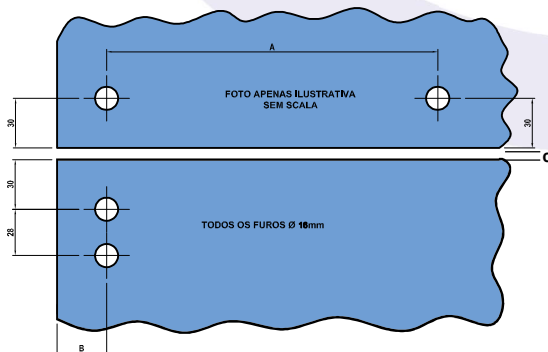

"A" - MEDIDA DA HASTE MENOS 50MM

"B" - LARGURA DO VIDRO MENOS A MEDIDA "A", DIVIDIDO POR DOIS (2) É IGUAL A DISTÂNCIA DA BORDA DO VIDRO AO EIXO DO FURO

"C" - FOLGA MÍNIMA 3MM E MÁXIMO 8MM

HTVA

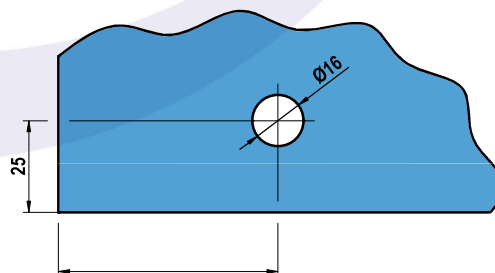

LARGURA DO VIDRO (MENOS) TAMANHO DA HASTE, (DIVIDIDO) POR DOIS (2).

Porta Cadeado

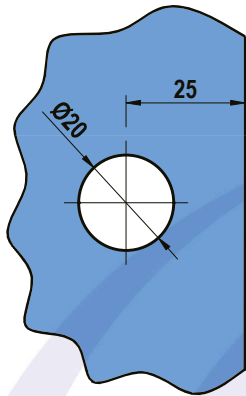

Puxador Unha - 1629A, 629J, 607, 629B, e 1636

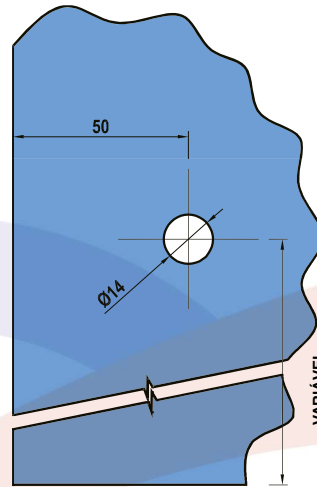

MÃO AMIGA

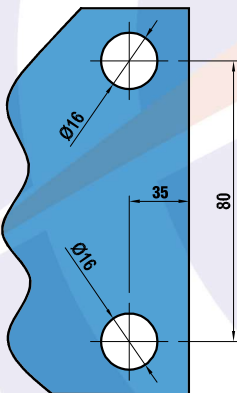

Transpasse 100 mm

MÃO AMIGA MINI

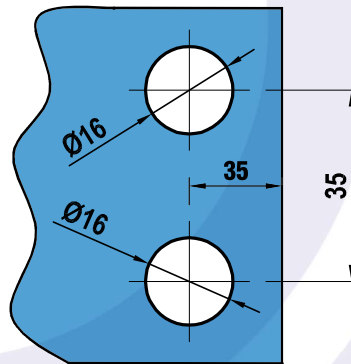

Transpasse 100 mm

72 A, 72 B

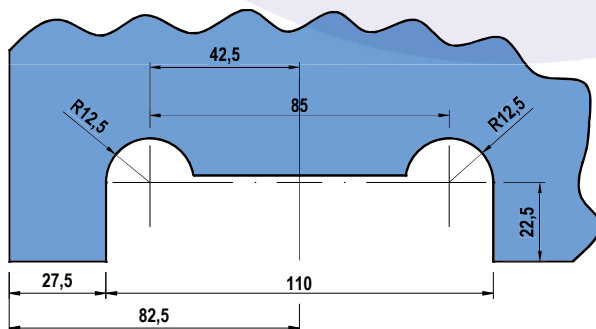

Seja Bem Vindo!

Você acaba de se tornar, mais um membro da família Glasspeças !!!

Para nós é uma honra tê-lo como cliente!

O vidro temperado oferece segurança, design e infinitas possibilidades de utilização. No entanto, para que seu desempenho seja ampliado, é necessário preocupar-se também com as ferragens e acessórios que farão parte da instalação. É nesse propósito que surge a Glasspeças®, para oferecer ao vidraceiro, instalador, temperador e distribuidor, uma ferragem de qualidade, rigorosamente testada, que oferece ainda design, excelente custo benefício e versatilidade de utilização, evitando assim futuros retrabalhos.

Segue abaixo, algumas dicas de uso, instalação e manutenção das ferragens Glasspeças:

Chaves para instalação das ferragens:

Todas as Ferragens utilizam a chave de 3/16, nos Puxadores H, utilizam a chave 3/32 e os Puxadores 1276 e 1376 utilizam a chave 1/8, na ferragem Suporte para Guarda Corpo e 1120/1121 utilizam a chave de 4mm.

Limpeza das Ferragens:

A limpeza deverá ser periódica (Zona Marítima 1 vez por mês, Zona Industrial 1 vez a cada 6 meses, Zona de Baixo Risco de Agressão, 1 vez a 18 meses), com detergente ou sabão neutro realizada com pano macio, não sendo aconselhado o uso de sabão em pó, por ser alcalino, bucha de aço e água sanitária.

Garantia:

Nossas ferragens e ou acessórios, possuem garantia de **CINCO** anos da data de compra, para possível defeito de fabricação.

Departamento técnico:

Temos à sua disposição, um departamento técnico, para eventuais dúvidas e mais ainda, para desenvolvimento de ferragens especiais, de acordo com a sua necessidade. Caso necessite entre em contato:

Telefone: (11) 5670-9900 - Celular: (11) 94028-9502

E-mail: tecnico@glasspecas.com.br

Visitas:

Colocamo-nos à disposição para visitas em nossa fábrica. Conheça você também o encantador mundo da produção das ferragens. Ligue-nos e agende sua visita, Telefone (11) 5670-9900.

Código das cores das ferragens:

Em nossa empresa, todos os códigos das ferragens iniciam com o código correspondente a cor da ferragem, sendo eles: 9 Cromada, 8 Preto, 7 Bronze, 6 Dourado, 5 Branco, 4 Marrom, PF Pintura Fosca, CE Cromo Escovado, CH Champanhe e BG Bege.

Acabamento

Impressão e Edição Março/2017



Branco



Cromado



Preto



Cromo Escovado



Bege



Pintura Fosca



Marrom



Dourado
(Garantia de 6 meses)



Vermelho



Champagne



Azul



Bronze



Verde

É proibida a reprodução total ou parcial deste catálogo sem autorização da Glasspeças Ind. e Com. Ltda. Todas as fotos desenhos e dimensões são meramente ilustrativos, podendo ser alterados sem prévio aviso.



Glasspeças
20 anos

Tel.: +55 11 5670-9900 | 11 3474-9900 | 11 94787-9478 

Rua Alto do Bonfim, 328 | Vila Santa Catarina | 04382-070 | São Paulo - SP
vendas@glasspecas.com.br | www.glasspecas.com.br